

- Standard Voltage to 250 V AC/400 V DC, 5 A
- Cable Assemblies
- Cable Connectors & Connector Blocks
- Breakouts & PCB Connectors
- Guaranteed Compatibility
- High Voltage Solutions are also Available
See Data Sheet 90-007HVD



Simple Connection

Pickering connection solutions provide a simple way of connecting to a user's device under test or remote connection. The products include cable assemblies, cable connectors, connector blocks, breakouts and pcb connectors.

Cable Assemblies

Cable assemblies are offered in connector to connector, and connector to unterminated versions. There are 3 termination options for the unterminated cables - ferrules, tinned copper or simple cut end.

Connector Blocks and Breakouts

Connector Blocks convert the 37-pin D-type connections to an array of screw terminals. The customer can then interface to other devices using his own wiring. An alternative is a remote Breakout with screw terminals at the end of a cable assembly.

Custom Design Needs

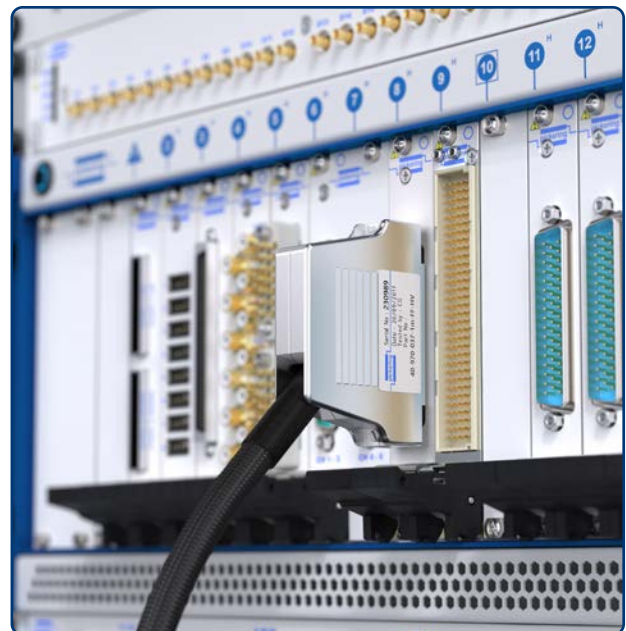

Pickering Interfaces can manufacture custom connector accessories to suit any application. If you do not see what you need in this data sheet contact your Pickering Interfaces sales office with information on your requirements or consider using our free online Cable Design Tool.

Using our Cable Design Tool, you can graphically design your own custom cable assembly. Once completed and submitted, our engineers will generate a quote for your cable requirements. See pickeringtest.com/cdt







Examples of Pickering PXI and LXI Products using 37-Pin D-type Connectors

Standard Voltage - Cable Assemblies

Description		End 1	End 2		Cable Length	Product Order Code and Part Number	Data Sheet Page
		Gender & Cable Exit	Gender & Cable Exit	Options			
	Cable Assy, 37-Pin D-Type, 5 A	Male, 45° Towards Pin 1	Female, 45° Away from Pin 1	-	0.5 m 1 m 2 m	40-970-037-0.5m-MF 40-970-037-1m-MF 40-970-037-2m-MF	5
		Female, 45° Away from Pin 1	Female, 45° Away from Pin 1	-	0.5 m 1 m 2 m	40-970-037-0.5m-FF 40-970-037-1m-FF 40-970-037-2m-FF	6
	Cable Assy, 37-Pin D-Type to Underterminated, 5 A	Female, 45° Away from Pin 1	NA	Ferrules	0.5 m 1 m 2 m	40-972-037-0.5m-FU 40-972-037-1m-FU 40-972-037-2m-FU	7
				Tinned End	0.5 m 1 m 2 m	A037DF4-T-0A050 A037DF4-T-0A100 A037DF4-T-0A200	
				Cut End	0.5 m 1 m 2 m	A037DF4-C-0A050 A037DF4-C-0A100 A037DF4-C-0A200	



Note: Custom lengths by quotation

Standard Voltage - Female Connector Blocks/Connectors

Description		Gender & Cable Exit	Type	Product Order Code and Part Number	Page
	Shielded Connector Block, 37-Pin D-Type, 5 A, Screw Terminal	Female, Rear	With Backshell	40-965-037-F	8
			Without Backshell	92-965-037-F	
	Breakout with DIN Rail Mount, 37-Pin D-Type, 5 A, Screw Terminal	Female	DIN Rail Mount	40-967-037-F	9
	Cable Connector 37-Pin D-Type, 5 A, Solder Bucket	Female, 45° Options	With Backshell	40-960-037-F	10
			Without Backshell	92-960-037-F	
	PCB Connector 37-Pin D-Type, 5 A	Female	Right Angle PCB Mount	40-963-037-RF	11
			Straight PCB Mount	40-963-037-SF	12

Please click on the page number to navigate to the data sheet page required. Return to this page via the **C** button.

Standard Voltage - Male Breakouts/PCB Connectors

Description		Gender & Cable Exit	Type	Product Order Code and Part Number	Page
	Breakout with DIN Rail Mount, 37-Pin D-Type, 5 A, Screw Terminal	Male	DIN Rail Mount	40-967-037-M	13
	PCB Connector 37-Pin D-Type, 5 A	Male	Right Angle PCB Mount	40-963-037-RM	14
			Straight PCB Mount	40-963-037-SM	15



Standard Voltage - Calibration Cables

Description	End 1	End 2	Cable Length	Product Order Code and Part Number	Data Sheet Page
	Type	Type			
 Cable Assy, 37-Pin D-Type, Female, to 4 x 4 mm DMM Bayonet Plug	37-Pin D-Type Female, Cable Exit 45° Away from Pin 1	4 x 4mm DMM Bayonet Plug	1m	40-975-037-02-1m (For Modules 40-293 and 50-293)	16
				40-975-037-1m (For Modules 40-297 and 50-297)	

Additional Accessories



Although the items below do not directly mate with Pickering Interfaces products, customers may find them useful in the development of their own connection solutions.

Standard Voltage - Cable Assemblies

Description		End 1	End 2		Cable Length	Product Order Code and Part Number	Data Sheet Page
		Gender & Cable Exit	Gender & Cable Exit	Options			
	Cable Assy, 37-Pin D-Type, 5 A	Male, 45° Towards Pin 1	Male, 45° Towards Pin 1	-	0.5 m 1 m 2 m	40-970-037-0.5m-MM 40-970-037-1m-MM 40-970-037-2m-MM	18
	Cable Assy, 37-Pin D-Type to Unterminated, 5 A	Male, 45° Towards Pin 1	NA	Ferrules	0.5 m 1 m 2 m	40-972-037-0.5m-MU 40-972-037-1m-MU 40-972-037-2m-MU	19
				Tinned End	0.5 m 1 m 2 m	A037DM5-T-0A050 A037DM5-T-0A100 A037DM5-T-0A200	
				Cut End	0.5 m 1 m 2 m	A037DM5-C-0A050 A037DM5-C-0A100 A037DM5-C-0A200	

Note: Custom lengths by quotation

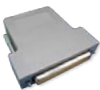
Standard Voltage - Male Connector Blocks/Connectors

Description	Gender & Cable Exit	Type	Product Order Code and Part Number	Page
	Male, Rear	With Backshell	40-965-037-M	20
		Without Backshell	92-965-037-M	
	Male, 45° Options	With Backshell	40-960-037-M	21
		Without Backshell	92-960-037-M	

Custom Termination

Customization Possibilities 22

- High Specification, Highly Flexible Cable
- Fully Screened Cable Construction with Strain Relief
- 45 Degree Cable Exit

Technical Specification

Connector Type (End A):	37-Pin D-Subminiature
Gender	Female
Securing Method	4-40 UNC screwlocks, male
Connector Type (End B):	37-Pin D-Subminiature
Gender	Male
Securing Method	4-40 UNC screwlocks, male
Maximum Current	5 A
Maximum Voltage	250 VAC/400 VDC
Insulation Resistance	1000 MOhm
Connectors:	
Contact Material	Gold plated copper alloy
Contact Resistance	<20 mOhm
Cable Exit:	
Female Connectors	45° (Away from Pin 1)
Male Connectors	45° (Towards Pin 1)
Overall Size (Approx)	H70 x W18.5 x D55 mm
Cable Type:	Individual wires, screened & sleeved
Conductor: Material	Tinned copper wire
Strands	19/0.18 (0.41mm ² , 21AWG)
Resistance	0.041Ω/m
Insulation	PFA
Outer Sleeve	Polyester
Screened Construction	Yes (Cable screen connected to backshells)
Additional Braided Sleeve	Yes
Cable O/D	10 mm
Minimum Bend Radius	25 mm
Door Closure Allowance	55 mm (see diagram)



37-Pin D-Type Cable Assembly

Product Compatibility

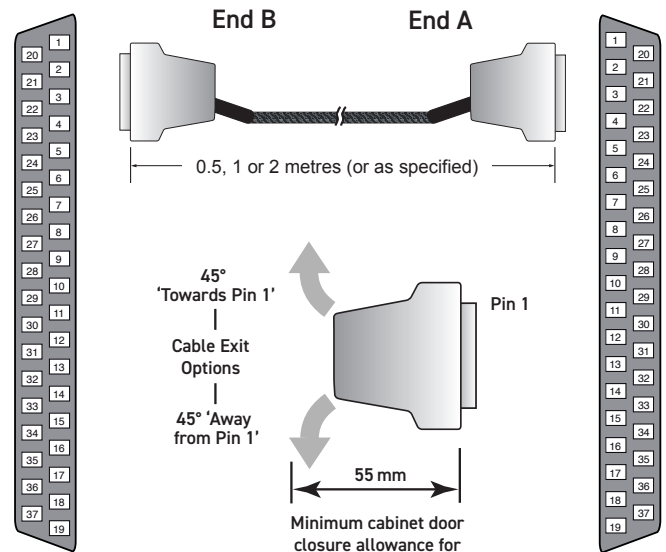
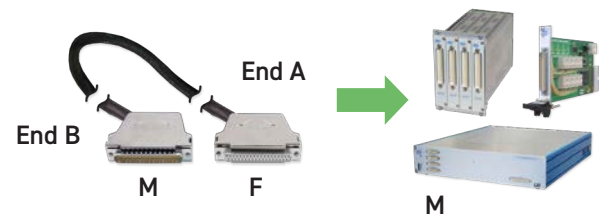

End B - Male Mating Face

End A - Female Mating Face

Characteristic Plots for 40-970-037-1m

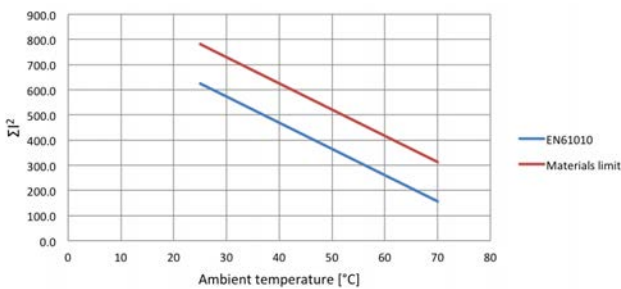

The graph shows the permitted ΣI^2 versus ambient temperature in accordance with EN61010 for user exposure to surface temperature and a higher limit imposed by the materials used where the cable is not directly user accessible.

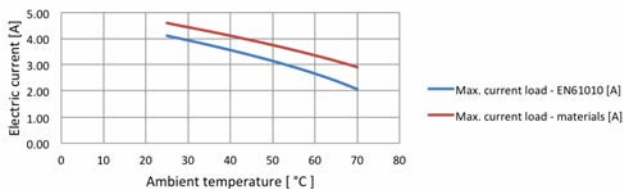

The graph shows the allowed current versus temperature assuming ALL wires carry the same current. Higher currents to the cable rating are permitted on individual wires provided the ΣI^2 is complied with.

Product Order Codes

- 37-Pin D-Type Cable Assy, 5 A, Male to Female,
- 0.5 m Long [40-970-037-0.5m-MF](#)
 - 1.0 m Long [40-970-037-1m-MF](#)
 - 2.0 m Long [40-970-037-2m-MF](#)

Note: Other cable lengths can be supplied.

- High Specification, Highly Flexible Cable
- Fully Screened Cable Construction with Strain Relief
- 45 Degree Cable Exit

Technical Specification

Connector Type (End A):	37-Pin D-Subminiature
Gender:	Female
Securing Method:	4-40 UNC screwlocks, male
Connector Type (End B):	37-Pin D-Subminiature
Gender:	Female
Securing Method:	4-40 UNC screwlocks, male
Maximum Current:	5 A
Maximum Voltage:	250 VAC/400 VDC
Insulation Resistance:	1000 MOhm
Connectors:	
Contact Material:	Gold plated copper alloy
Contact Resistance:	<20 mOhm
Cable Exit:	45° (Away from Pin 1)
Overall Size (Approx):	H70 x W18.5 x D55 mm
Cable Type:	Individual wires, screened & sleeved
Conductor: Material:	Tinned copper wire
Strands:	19/0.18 (0.41mm ² , 21AWG)
Resistance:	0.041 Ω/m
Insulation:	PFA
Outer Sleeve:	Polyester
Screened Construction:	Yes (Cable screen connected to backshells)
Additional Braided Sleeve:	Yes
Cable O/D:	10 mm
Minimum Bend Radius:	25 mm
Door Closure Allowance:	55 mm (see diagram)



37-Pin D-Type Cable Assembly

Product Compatibility

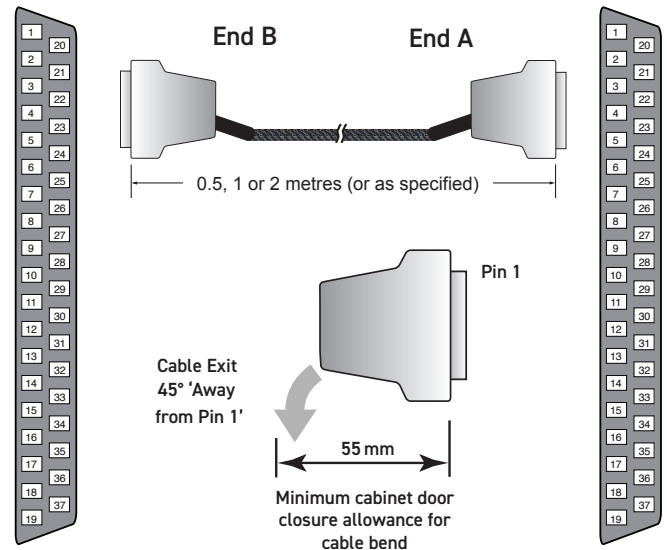
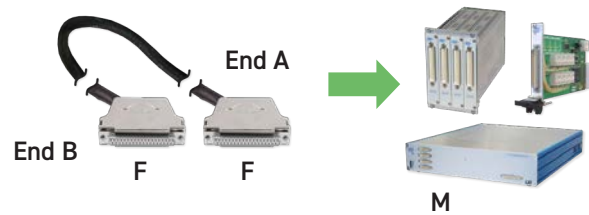

End B - Female Mating Face

End A - Female Mating Face

Characteristic Plots for 40-970-037-1m

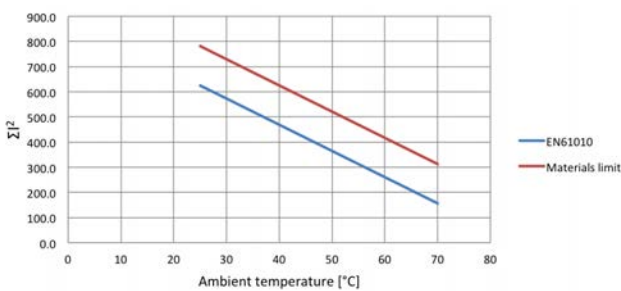

The graph shows the permitted ΣI^2 versus ambient temperature in accordance with EN61010 for user exposure to surface temperature and a higher limit imposed by the materials used where the cable is not directly user accessible.

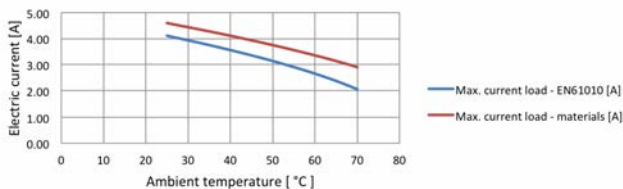

The graph shows the allowed current versus temperature assuming ALL wires carry the same current. Higher currents to the cable rating are permitted on individual wires provided the ΣI^2 is complied with.

Product Order Codes

37-Pin D-Type Cable Assy, 5 A, Female to Female, Cable Exit 45° (Away from Pin 1),

0.5 m Long 40-970-037-0.5m-FF

1.0 m Long 40-970-037-1m-FF

2.0 m Long 40-970-037-2m-FF

Note: Other cable lengths can be supplied.

- High Specification, Highly Flexible Cable
- Fully Screened Cable Construction with Strain Relief
- Fully Coded Markers to Ensure Easy Connection

Technical Specification

Connector Type (End A):	37-Pin D-Subminiature
Gender	Female
Securing Method	4-40 UNC screwlocks, male
Unterminated End (End B):	
Free Wire Length	130 mm nominal
Individual Wire Labelling	To connector pins A white/black screen pigtail is also included
Wire End Options	Ferrules, Tinned, Cut End
Maximum Current	5 A
Maximum Voltage	250 VAC/400 VDC
Insulation Resistance	1000 MOhm
Connector:	
Contact Material	Gold plated copper alloy
Contact Resistance	<20 mOhm
Cable Exit	45° (Away from Pin 1)
Overall Size (Approx)	H70 x W18.5 x D55 mm
Cable Type:	Individual wires, screened & sleeved
Conductor: Material	Copper
Strands	19/0.18 (0.41mm ² , 21AWG)
Resistance	0.041 Ω/m (max)
Insulation	PFA
Outer Sleeve	Polyester
Screened Construction	Yes (Cable screen connected to backshell)
Additional Braided Sleeve	Yes
Cable O/D	10 mm
Minimum Bend Radius	25 mm
Door Closure Allowance	55 mm (see diagram)

Note: When using this product please ensure appropriate electrical safety.

Characteristic Plots for 40-972-037-1m

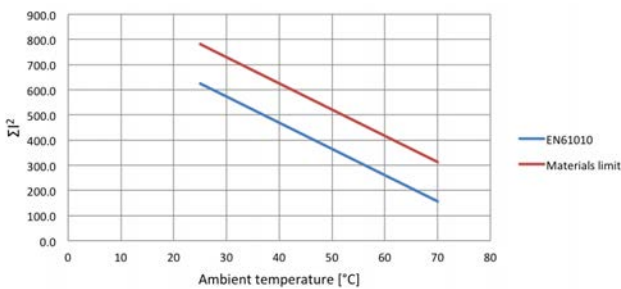

The graph shows the permitted ΣI^2 versus ambient temperature in accordance with EN61010 for user exposure to surface temperature and a higher limit imposed by the materials used where the cable is not directly user accessible.

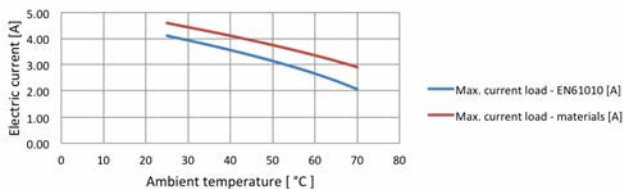

The graph shows the allowed current versus temperature assuming ALL wires carry the same current. Higher currents to the cable rating are permitted on individual wires provided the ΣI^2 is complied with.

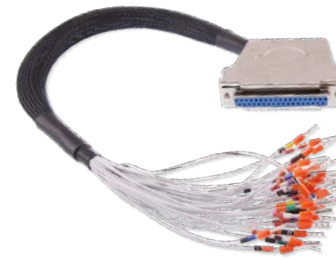

37-Pin D-Type Unterminated Cable Assembly

Product Compatibility

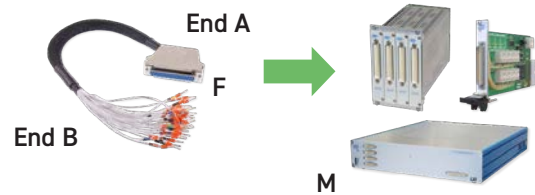

End B Options

Ferrules
Dia as Sleeve
7 mm Nom

Soldered or Crimped Construction

Tinned End
Dia as Tinned Wire
6 mm Nom

Cut End
Simple Cut

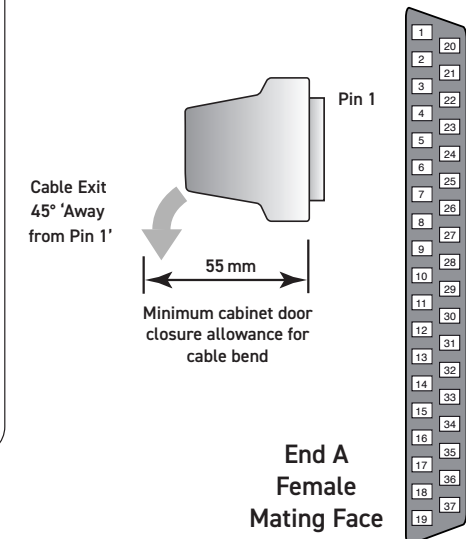
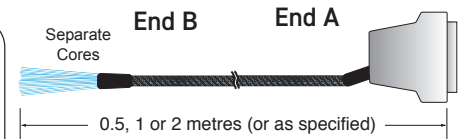

Product Order Codes

- 37-Pin D-Type Cable Assy, 5 A, Boot Lace Ferrules, Female to Unterminated, 0.5 m Long **40-972-037-0.5m-FU**
 Female to Unterminated, 1.0 m Long **40-972-037-1m-FU**
 Female to Unterminated, 2.0 m Long **40-972-037-2m-FU**

Part numbers for other versions:

A037DF4-*-0A***

End B:
T = Tinned End
C = Cut End

Cable Length:
050 = 0.5 m
100 = 1.0 m
200 = 2.0 m

Note: Other cable lengths can be supplied.

- Connector & PCB Only or Connector, PCB & Backshell
- Male Screwlocks
- Easy to Use Rising Cage Screw Terminals

Connector blocks provide a convenient method of termination without the use of custom cabling. However, a higher resistance path, lower capacity ratings and lower voltage ratings are typical.

The screw terminals use a rising cage clamp mechanism to minimize risk of copper strand breakage. PFA cables are recommended for use with this connector block to maximise copper cross-sectional area and insulation properties. The breakdown voltage of the connector block is controlled by clearances to the metal shell. The metal shell includes an internal insulation barrier under the carrier board.

This connector block uses male screwlocks and will not mate to Pickering cables. Connector blocks supplied without a backshell do not include cable strain relief.

Technical Specification

Connector Type:	37-Pin D-Subminiature
Gender	Female
Securing Method:	
Product with Backshell	4-40 UNC screwlocks, male
Product without Backshell	4-40 UNC screwlocks, male or female
Wire Connection	Rising cage screw terminals
	A screen (GND) connection is provided
Connector Block Ratings:	
Maximum Current	5 A
Maximum Voltage	200 VDC
Cable Exit	Rear - 18 x 24 mm
Overall Size (Approx)	H76 x W17.5 x D77 mm
37-Pin D-Sub:	
Contact Material	Gold plated copper alloy
Contact Resistance	<20 mOhm
Screw Terminals:	
Maximum Wire Size	20AWG
Recommended Insulation	PFA
Additional Cable Clamp	Yes (in backshell)

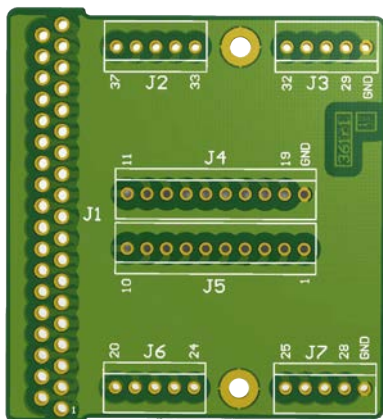

PCB Legend

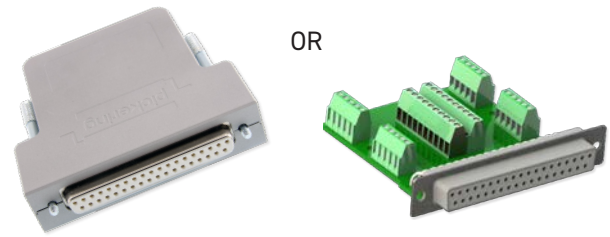

37-Pin D-Type Connector Block

Product Compatibility

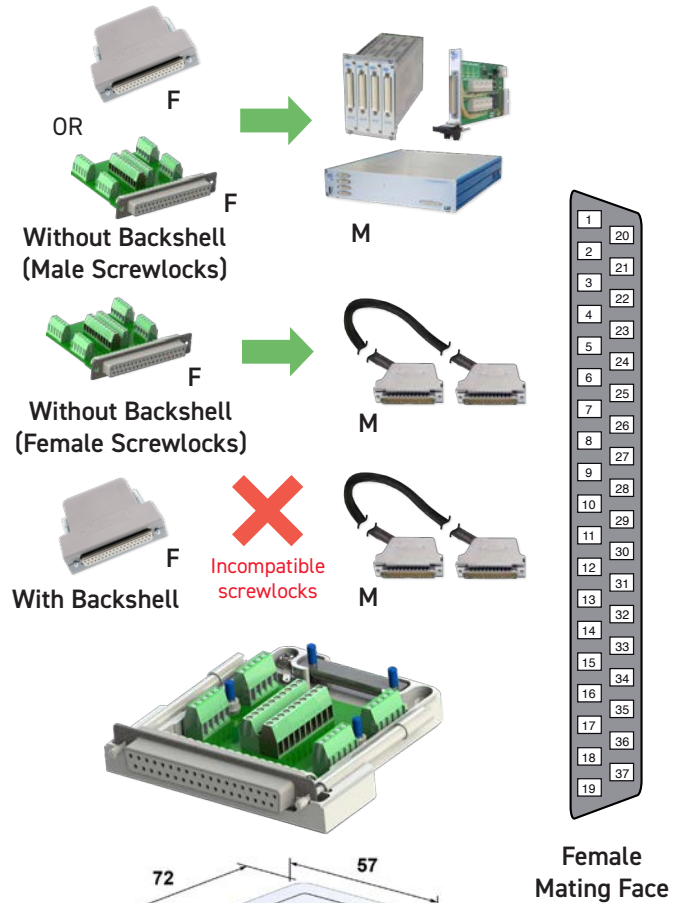

Female Mating Face

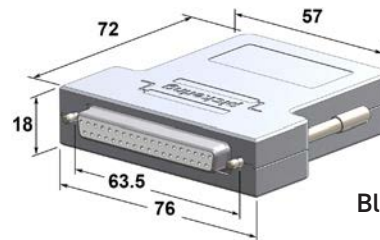

Connector Block Dimensions

Product Order Codes

- 37-Pin D-Type Shielded Connector Block, 5 A, Screw Terminal,
 With Backshell, Female [40-965-037-F](#)
 Without Backshell, Female [92-965-037-F](#)

Note: Male and female screwlocks are provided for connector blocks without a backshell.

- For Connection at Cable End
- Simple to Use Rising Cage Screw Clamp Termination
- DIN Rail Mounted

Connector blocks provide a convenient method of termination without the use of custom cabling. However, a higher resistance path, lower capacity ratings and lower voltage ratings are typical.

This termination option is capable of accepting heavy duty connection wires and uses rising clamp screw terminals to minimize the danger of copper strand damage. Users should care take to protect the termination and provide a suitable method of restraining the cables.

When using this product please ensure appropriate electrical safety precautions are observed.

Technical Specification

Connector Type:	37-Pin D-Subminiature
Gender	Female
Securing Method:	4-40 UNC screwlocks, female
Wire Connection	Rising cage screw terminals A screen connection is provided
Breakout Ratings:	
Maximum Current	5 A
Maximum Voltage	200 VDC
Securing Method	Suitable for securing to DIN rails.
Overall Size (Approx)	H110 x W110 x D56 mm
37-Pin D-Sub:	
Contact Material	Gold plated copper alloy
Contact Resistance	<20 mOhm
Screw Terminals:	
Maximum Wire Size	12AWG
Additional Cable Clamp	No

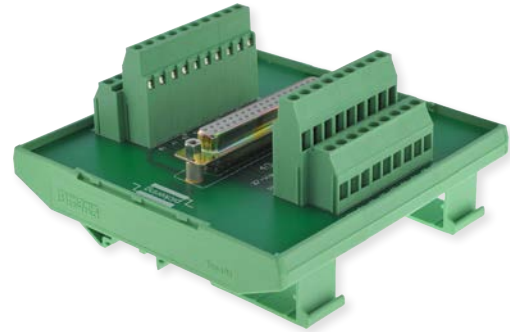

37-Pin D-Type Breakout

Product Compatibility

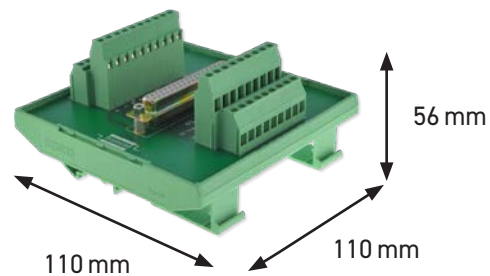
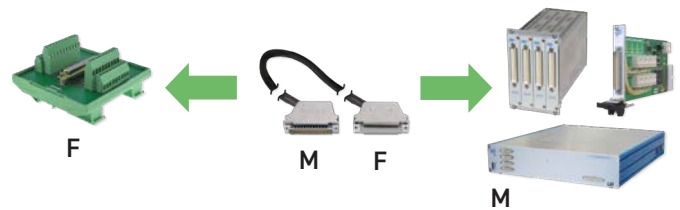

Breakout Dimensions

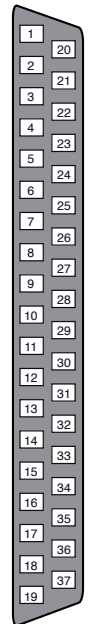

Female Mating Face

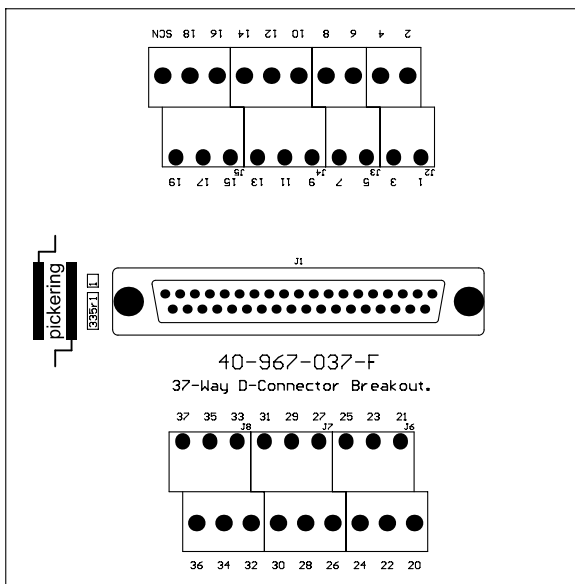

PCB Layout

Product Order Codes

37-Pin D-Type Breakout with DIN Rail Mount, 5 A, Screw Terminal, Female **40-967-037-F**

- Connector only or Connector and Backshell
- Cable Clamp in Backshell
- Soldered Cable Termination

This accessory is designed to allow users to directly terminate with soldered connections to the connector.

Connector and shell are supplied separately to allow the user to determine the direction of the cable exit.

When the product is used without a backshell users should make their own cable strain relief arrangements and ensure appropriate electrical safety precautions are observed.



37-Pin D-Type Cable Connector

Product Compatibility

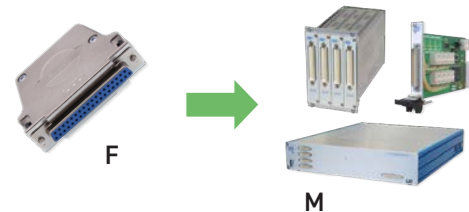

Technical Specification

Connector Type:	37-Pin D-Subminiature
Gender	Female
Securing Method:	
Product with Backshell	4-40 UNC screwlocks, male
Product without Backshell	4-40 UNC screwlocks, male
Wire Connection	Solder bucket. A backshell fixing is also provided for a cable screen
Connector Ratings:	
Maximum Current	5 A
Maximum Voltage	250 VAC
Cable Exit:	45°
Cable Exit Size	13 mm dia
Overall Size (Approx)	H70 x W18.5 x D55 mm
37-Pin D-Sub:	
Contact Material	Gold plated copper alloy
Contact Resistance	20 mOhm
Wire Connection:	
Maximum Wire Size	20AWG
Recommended Insulation	PFA
Additional Cable Clamp	Yes (in backshell)

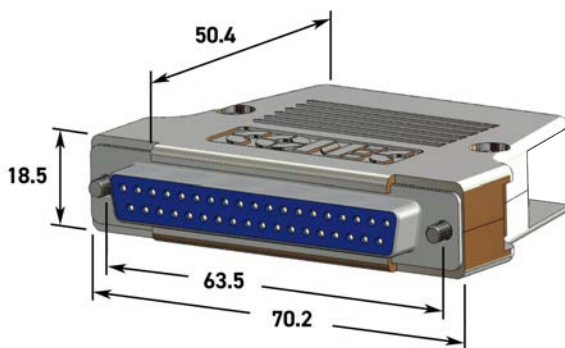
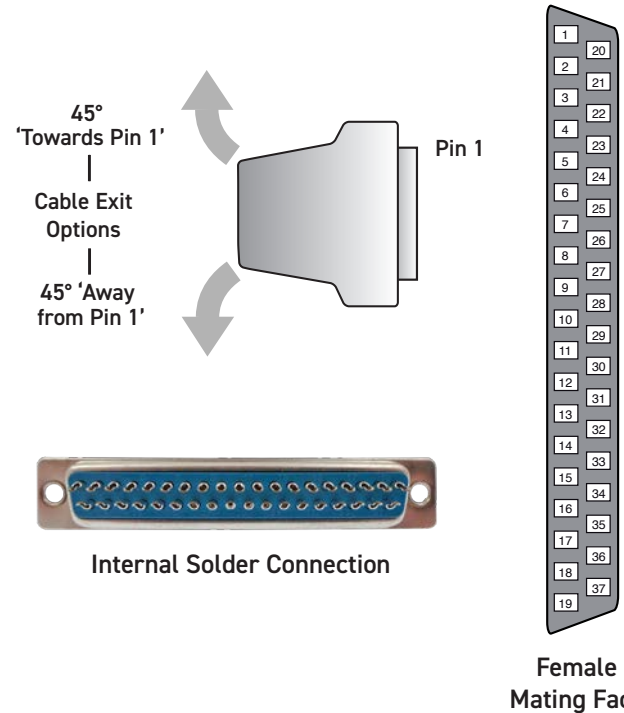

Backshell Dimensions

Internal Solder Connection

Product Order Codes

37-Pin D-Type Connector, 5 A, Solder Bucket, With Backshell, Female	40-960-037-F
Without Backshell, Female	92-960-037-F

- Right Angle PCB Mount
- Ideal for User Created Termination Solutions

This accessory allows a user to create their own PCB based termination solution mounted on the end of a cable. Suitable cables for this product are contained elsewhere in this data sheet. Interfacing PCBs should be designed with suitable clearances for the voltage the application requires.

Note: This product is not suitable for directly mounting onto the front panel of a Pickering switching product.

Technical Specification

Connector Type:	37-Pin D-Subminiature
Gender	Female
Securing Method	4-40 UNC screwlocks, female
PCB Mounting	Right angle PCB mount, solder
Connector Ratings:	
Maximum Current	5 A each pin
Maximum Voltage	250 VAC
37-Pin D-Sub:	
Contact Material	Gold plated copper alloy
Contact Resistance	<20 mOhm
PCB Legs:	
Effective Leg Length	5.0 mm nom (See diagram)

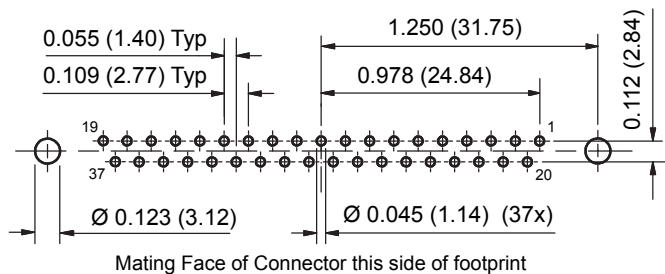

PCB Footprint of 37-Pin Right Angle Female Connector
(Connector Side - Not to Scale)

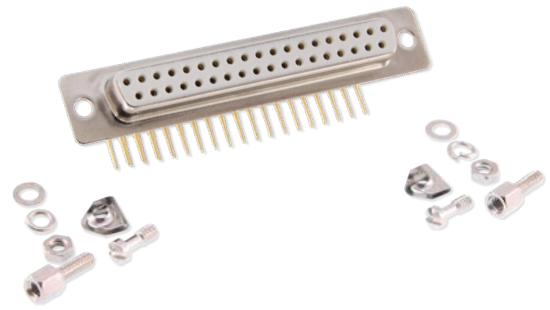

37-Pin D-Type PCB Connector

Product Compatibility

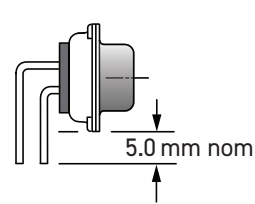
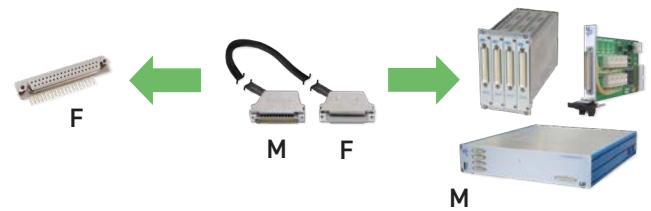

Effective Leg Length

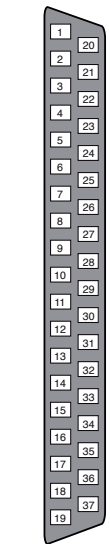
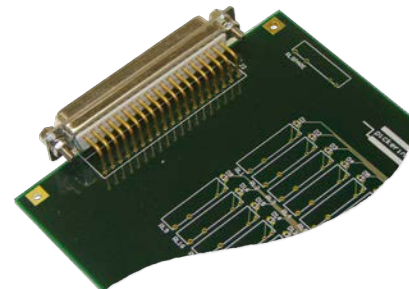

Female Mating Face

Product Order Codes

37-Pin D-Type Connector, 5 A, Right Angle PCB Mount, Female
[40-963-037-RF](#)

- Straight PCB Mount
- Ideal for User Created Termination Solutions

This accessory allows a user to create their own PCB based termination solution mounted on the end of a cable. Suitable cables for this product are contained elsewhere in this data sheet. Interfacing PCBs should be designed with suitable clearances for the voltage the application requires.

Note: This product is not suitable for directly mounting onto the front panel of a Pickering switching product.

Technical Specification

Connector Type:	37-Pin D-Subminiature
Gender	Female
Securing Method	4-40 UNC screwlocks, female
PCB Mounting	Straight PCB mount, solder
Connector Ratings:	
Maximum Current	5 A each pin
Maximum Voltage	250 VAC
37-Pin D-Sub:	
Contact Material	Gold plated copper alloy
Contact Resistance	<20 mOhm
PCB Legs:	
Leg Length	4.6 mm nom (See diagram)

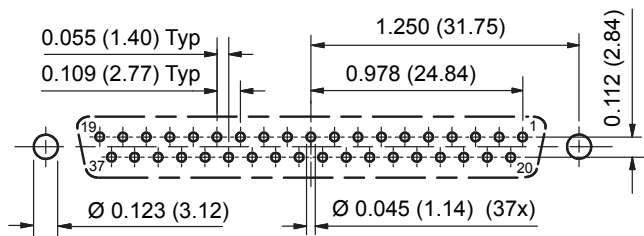

PCB Footprint of 37-Pin Straight Female Connector
(Connector Side - Not to Scale)

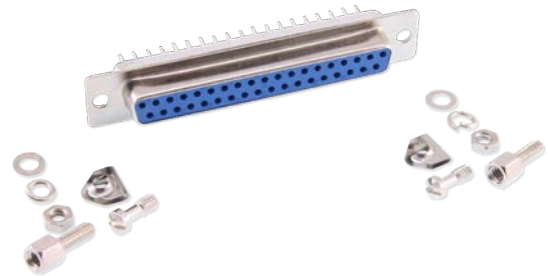

37-Pin D-Type PCB Connector

Product Compatibility

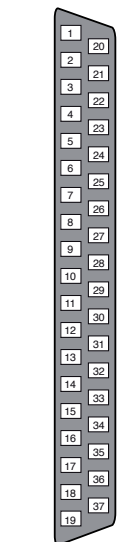
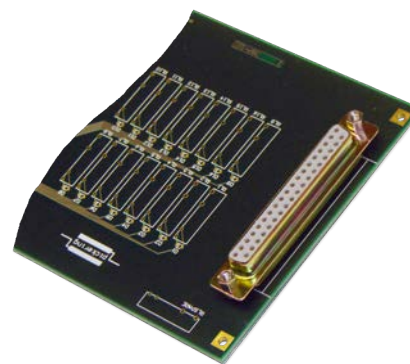
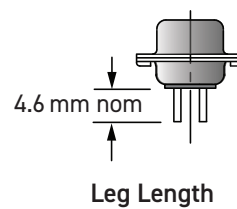
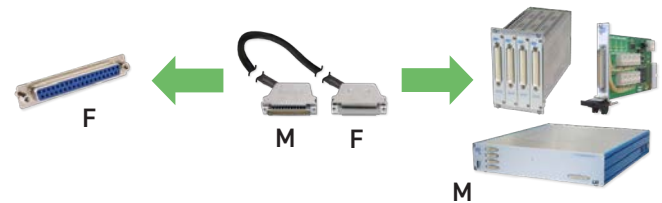

Female Mating Face

Product Order Codes

37-Pin D-Type Connector, 5 A, Straight PCB Mount, Female [40-963-037-SF](https://www.pickeringtest.com/40-963-037-SF)

- For Connection at Cable End
- Simple to Use Rising Cage Screw Clamp Termination
- DIN Rail Mounted

Connector blocks provide a convenient method of termination without the use of custom cabling. However, a higher resistance path, lower capacity ratings and lower voltage ratings are typical.

This termination option is capable of accepting heavy duty connection wires and uses rising clamp screw terminals to minimize the danger of copper strand damage. Users should care take to protect the termination and provide a suitable method of restraining the cables.

When using this product please ensure appropriate electrical safety precautions are observed.

Technical Specification

Connector Type:	37-Pin D-Subminiature
Gender	Male
Securing Method:	4-40 UNC screwlocks, female
Wire Connection	Rising cage screw terminals A screen connection is provided
Breakout Ratings:	
Maximum Current	5 A
Maximum Voltage	200 VDC
Securing Method	Suitable for securing to DIN rails.
Overall Size (Approx)	H110 x W110 x D56 mm
37-Pin D-Sub:	
Contact Material	Gold plated copper alloy
Contact Resistance	<20 mOhm
Screw Terminals:	
Maximum Wire Size	12AWG
Additional Cable Clamp	No

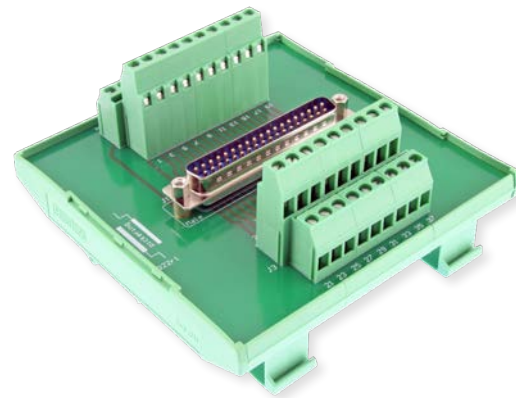

37-Pin D-Type Breakout

Product Compatibility

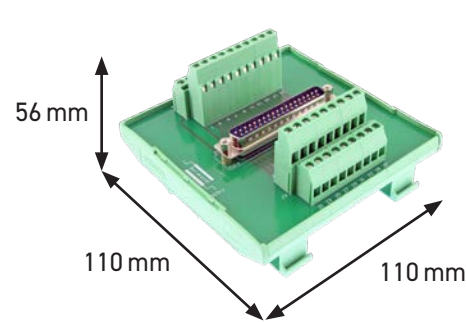
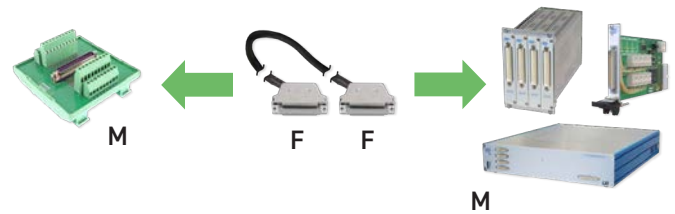

Male Mating Face

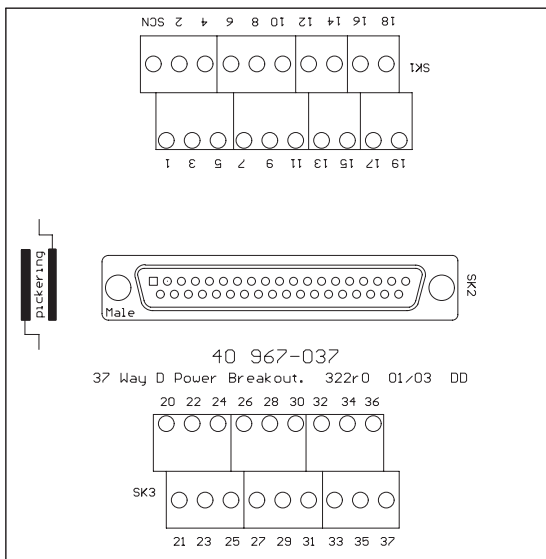

PCB Layout

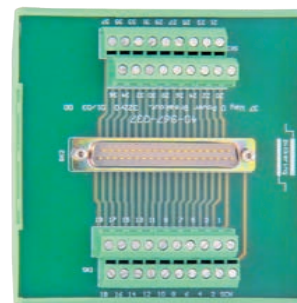

Product Order Codes

37-Pin D-Type Breakout with DIN Rail Mount, 5 A, Screw Terminal, Male

[40-967-037-M](#)

- Right Angle PCB Mount
- Ideal for User Created Termination Solutions

This accessory allows a user to create their own PCB based termination solution mounted on the end of a cable. Suitable cables for this product are contained elsewhere in this data sheet. Interfacing PCBs should be designed with suitable clearances for the voltage the application requires.

Note: This product is not suitable for directly mounting onto the front panel of a Pickering switching product.

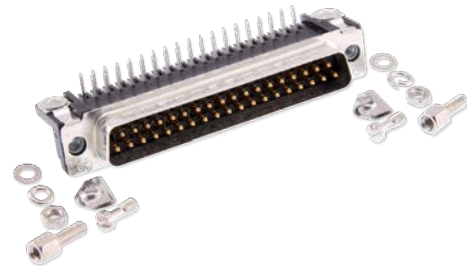

37-Pin D-Type PCB Connector

Technical Specification

Connector Type:	37-Pin D-Subminiature
Gender	Male
Securing Method	4-40 UNC screwlocks, female
PCB Mounting	Right angle PCB mount, solder
Connector Ratings:	
Maximum Current	5 A each pin
Maximum Voltage	250 VAC
37-Pin D-Sub:	
Contact Material	Gold plated copper alloy
Contact Resistance	<20 mOhm
PCB Legs:	
Effective Leg Length	3.2 mm nom (See diagram)

Product Compatibility

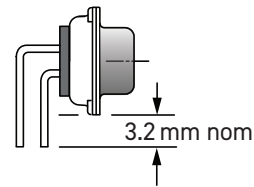
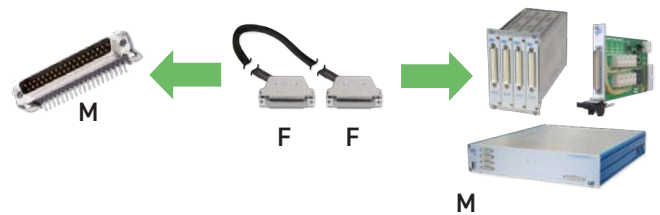

Effective Leg Length

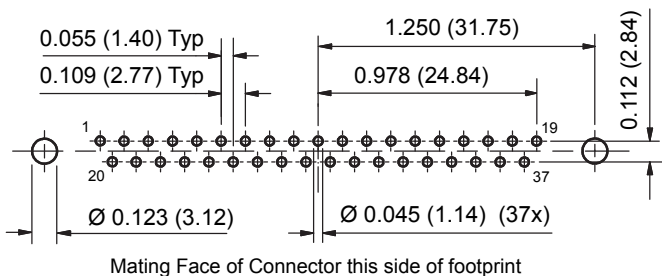

Mating Face of Connector this side of footprint

PCB Footprint of 37-Pin Right Angle Male Connector
(Connector Side - Not to Scale)

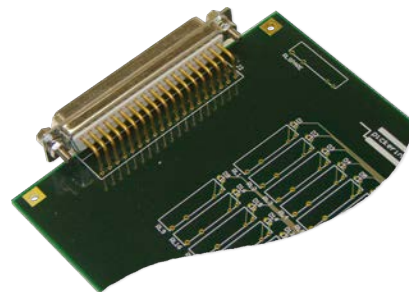

Male Mating Face

Product Order Codes

37-Pin D-Type Connector, 5 A, Right Angle PCB Mount, Male [40-963-037-RM](#)

- Straight PCB Mount
- Ideal for User Created Termination Solutions

This accessory allows a user to create their own PCB based termination solution mounted on the end of a cable. Suitable cables for this product are contained elsewhere in this data sheet. Interfacing PCBs should be designed with suitable clearances for the voltage the application requires.

Note: This product is not suitable for directly mounting onto the front panel of a Pickering switching product.



37-Pin D-Type PCB Connector

Technical Specification

Connector Type:	37-Pin D-Subminiature
Gender	Male
Securing Method	4-40 UNC screwlocks, female
PCB Mounting	Straight PCB mount, solder
Connector Ratings:	
Maximum Current	5 A each pin
Maximum Voltage	250 VAC
37-Pin D-Sub:	
Contact Material	Gold plated copper alloy
Contact Resistance	<20 mOhm
PCB Legs:	
Leg Length	4.6 mm nom (See diagram)

Product Compatibility

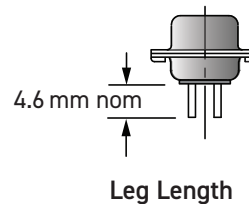
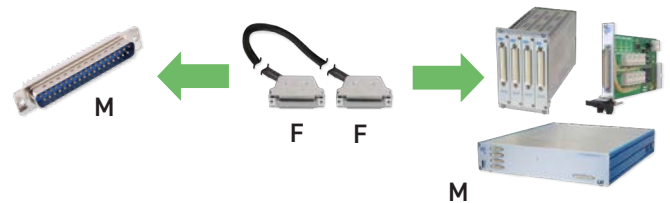

Male Mating Face

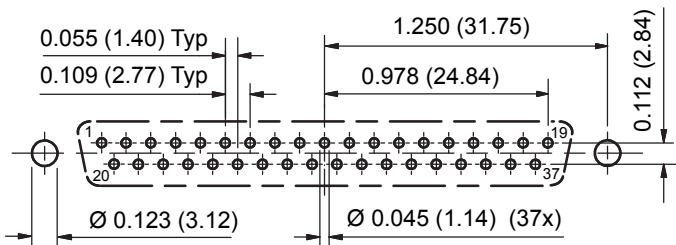

PCB Footprint of 37-Pin Straight Male Connector
(Connector Side - Not to Scale)

Product Order Codes

37-Pin D-Type Connector, 5 A, Straight PCB Mount, Male

40-963-037-SM

- High Specification Cable
- Stranded Hi-Flex PVC Cable
- Strain Relief
- 45 Degree Cable Exit

The calibration cable assemblies are specifically designed to connect to the 37-Pin D-Type port located on the front panel of Pickering Interfaces Precision Programmable Resistor Modules 40-293, 40-297, 50-293 and 50-297 enabling calibration via an external DMM.

Technical Specification

Connector Type (End A):	37-Pin D-Subminiature
Gender	Female
Securing Method	4-40 UNC screwlocks, male
Connector Type (End B):	4 x 4 mm DMM Bayonet Plug
Gender	Male
Securing Method	Push fit
Maximum Current	5 A
Maximum Voltage	750 V
Insulation Resistance	1000 MOhm
Connector (End A):	
Contact Material	Gold plated copper alloy
Contact Resistance	<20 mOhm
Cable Exit:	45° (Away from Pin 1)
Overall Size (Approx)	H70 x W18.5 x D55 mm
Connector (End B):	
Contact Material	Gold plated copper alloy
Contact Resistance	<20 mOhm
Overall Size (Approx)	50 x 8.5 mm dia
Cable Type:	Stranded Hi-Flex PVC
Conductor: Material	Tinned copper wire
Strands	259/0.07 (1.0 mm ² , 17AWG)
Resistance	-
Insulation	PVC
Outer Sleeve	Polyester
Screened Construction	No
Additional Braided Sleeve	Yes
Cable O/D	8 mm
Minimum Bend Radius	10 mm
Door Closure Allowance	55 mm (see diagram)

Note: The 2 cable assemblies listed feature different internal wiring although similar externally.



37-Pin D-Type Calibration Port Cable

Product Compatibility

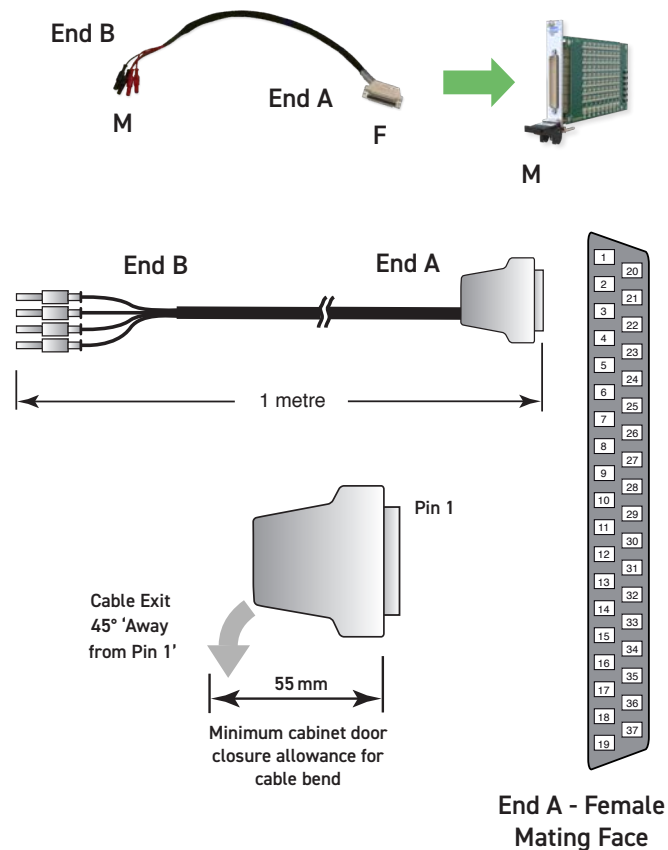

End A - Female Mating Face

Product Order Codes

For Modules 40-293 and 50-293:
37-Pin D-Type Connector, Female to
4 x 4 mm DMM Bayonet Plug, 1m. [40-975-037-02-1m](#)

For Modules 40-297 and 50-297:
37-Pin D-Type Connector, Female to
4 x 4 mm DMM Bayonet Plug, 1m. [40-975-037-1m](#)

Note: Other cable lengths can be supplied.

Additional Connection Accessories

Although these items do not directly mate with Pickering Interfaces products customers may find them useful in the development of their own connection solutions.

- High Specification, Highly Flexible Cable
- Fully Screened Cable Construction with Strain Relief
- 45 Degree Cable Exit

Technical Specification

Connector Type (End A):	37-Pin D-Subminiature
Gender	Male
Securing Method	4-40 UNC screwlocks, male
Connector Type (End B):	37-Pin D-Subminiature
Gender	Male
Securing Method	4-40 UNC screwlocks, male
Maximum Current	5 A
Maximum Voltage	250 VAC/400 VDC
Insulation Resistance	1000 MOhm
Connectors:	
Contact Material	Gold plated copper alloy
Contact Resistance	<20 mOhm
Cable Exit:	45° (Towards Pin 1)
Overall Size (Approx)	H70 x W18.5 x D55 mm
Cable Type:	Individual wires, screened & sleeved
Conductor: Material	Tinned copper wire
Strands	19/0.18 (0.41mm ² , 21AWG)
Resistance	0.041Ω/m
Insulation	PFA
Outer Sleeve	Polyester
Screened Construction	Yes (Cable screen connected to backshells)
Additional Braided Sleeve	Yes
Cable O/D	10 mm
Minimum Bend Radius	25 mm
Door Closure Allowance	55 mm (see diagram)

This Cable Assembly is Not Suitable for Connection to a Pickering Switching Product

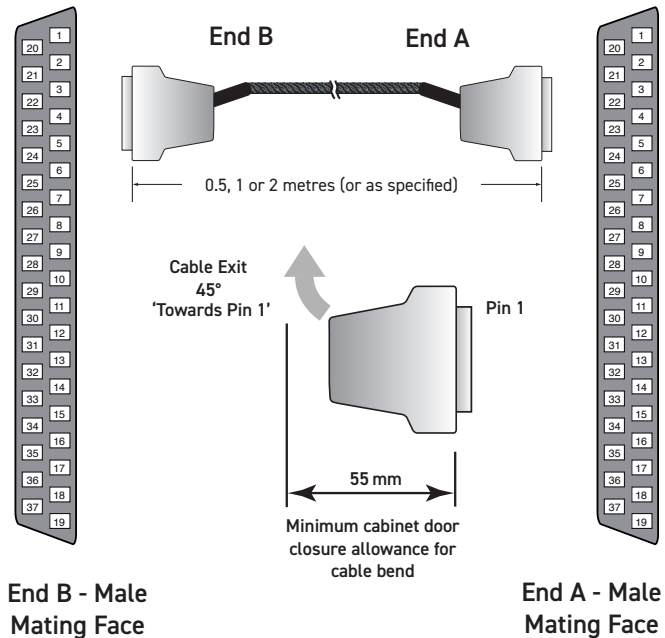
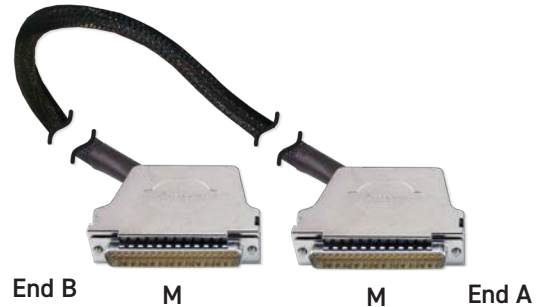

Characteristic Plots for 40-970-037-1m

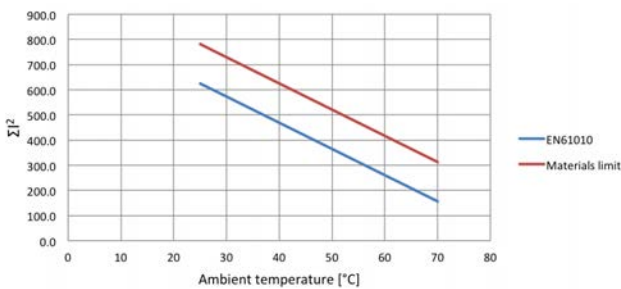

The graph shows the permitted ΣI^2 versus ambient temperature in accordance with EN61010 for user exposure to surface temperature and a higher limit imposed by the materials used where the cable is not directly user accessible.

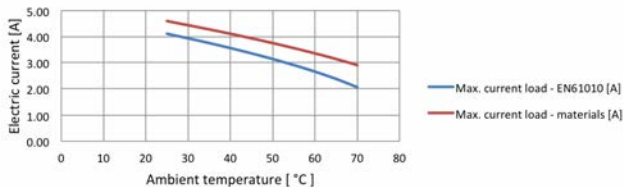

The graph shows the allowed current versus temperature assuming ALL wires carry the same current. Higher currents to the cable rating are permitted on individual wires provided the ΣI^2 is complied with.

End B - Male Mating Face

End A - Male Mating Face

Product Order Codes

37-Pin D-Type Cable Assy, 5 A, Male to Male, Cable Exit 45° (Towards Pin 1),

0.5 m Long

[40-970-037-0.5m-MM](#)

1.0 m Long

[40-970-037-1m-MM](#)

2.0 m Long

[40-970-037-2m-MM](#)

Note: Other cable lengths can be supplied.

- High Specification, Highly Flexible Cable
- Fully Screened Cable Construction with Strain Relief
- Fully Coded Markers to Ensure Easy Connection

Technical Specification

Connector Type (End A):	37-Pin D-Subminiature
Gender	Male
Securing Method	4-40 UNC screwlocks, male
Unterminated End (End B):	
Free Wire Length	130 mm nominal
Individual Wire Labelling	To connector pins
Wire End Options	A white/black screen pigtail is included Ferrules, Tinned, Cut End
Maximum Current	5 A
Maximum Voltage	250 VAC/400 VDC
Insulation Resistance	1000 MOhm
Connector:	
Contact Material	Gold plated copper alloy
Contact Resistance	<20 mOhm
Cable Exit	45° (Towards Pin 1)
Overall Size (Approx)	H70 x W18.5 x D55 mm
Cable Type:	Individual wires, screened & sleeved
Conductor: Material	Copper
Strands	19/0.18 (0.41mm ² , 21AWG)
Resistance	0.041 Ω/m (max)
Insulation	PFA
Outer Sleeve	Polyester
Screened Construction	Yes (Cable screen connected to backshell)
Additional Braided Sleeve	Yes
Cable O/D	10 mm
Minimum Bend Radius	25 mm
Door Closure Allowance	55 mm (see diagram)

Note: When using this product please ensure appropriate electrical safety.

Characteristic Plots for 40-972-037-1m

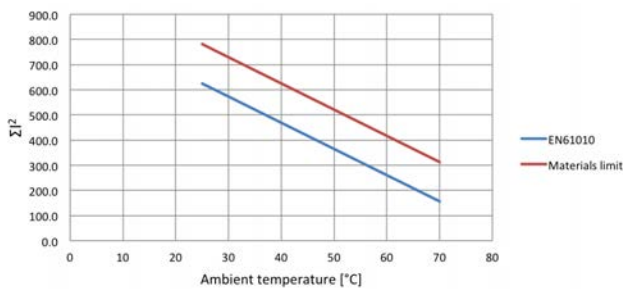

The graph shows the permitted ΣI^2 versus ambient temperature in accordance with EN61010 for user exposure to surface temperature and a higher limit imposed by the materials used where the cable is not directly user accessible.

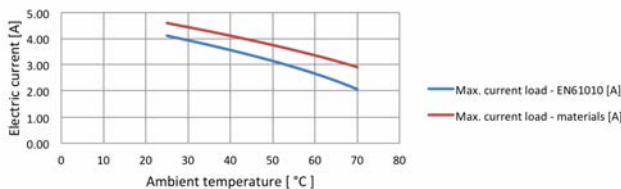

The graph shows the allowed current versus temperature assuming ALL wires carry the same current. Higher currents to the cable rating are permitted on individual wires provided the ΣI^2 is complied with.

This Cable Assembly is Not Suitable for Connection to a Pickering Switching Product

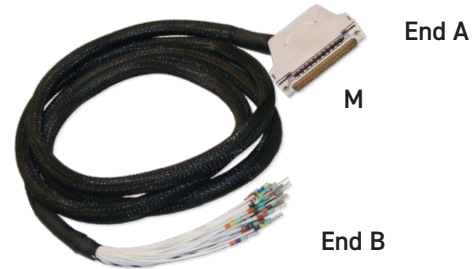

37-Pin D-Type Unterminated Cable Assembly

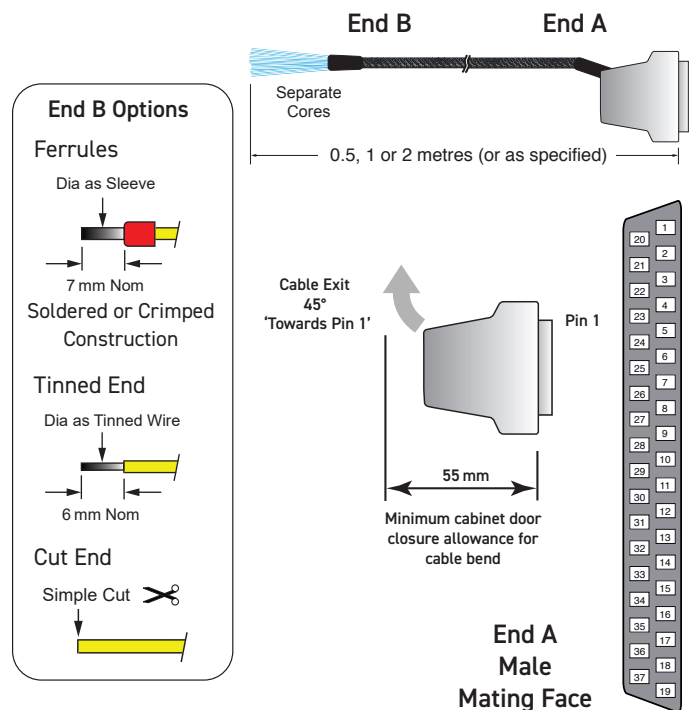

Product Order Codes

- 37-Pin D-Type Cable Assy, 5 A, Boot Lace Ferrules, Male to Unterminated, 0.5 m Long [40-972-037-0.5m-MU](#)
- Male to Unterminated, 1.0 m Long [40-972-037-1m-MU](#)
- Male to Unterminated, 2.0 m Long [40-972-037-2m-MU](#)

Part numbers for other versions:

A037DM5-*-0A***

End B:
T = Tinned End
C = Cut End

Cable Length:
050 = 0.5 m
100 = 1.0 m
200 = 2.0 m

Note: Other cable lengths can be supplied.

- Connector & PCB Only or Connector, PCB & Backshell
- Male Screwlocks
- Easy to Use Rising Cage Screw Terminals

Connector blocks provide a convenient method of termination without the use of custom cabling. However, a higher resistance path, lower capacity ratings and lower voltage ratings are typical.

The screw terminals use a rising cage clamp mechanism to minimize risk of copper strand breakage. PFA cables are recommended for use with this connector block to maximise copper cross-sectional area and insulation properties. The breakdown voltage of the connector block is controlled by clearances to the metal shell. The metal shell includes an internal insulation barrier under the carrier board.

This connector block uses male screwlocks and will not mate to Pickering cables. Connector blocks supplied without a backshell do not include cable strain relief.

Technical Specification

Connector Type:	37-Pin D-Subminiature
Gender	Male
Securing Method:	
Product with Backshell	4-40 UNC screwlocks, male
Product without Backshell	4-40 UNC screwlocks, male or female
Wire Connection	Rising cage screw terminals A screen (GND) connection is provided
Connector Block Ratings:	
Maximum Current	5 A
Maximum Voltage	200 VDC
Cable Exit	Rear - 18 x 24 mm
Overall Size (Approx)	H76 x W17.5 x D77 mm
37-Pin D-Sub:	
Contact Material	Gold plated copper alloy
Contact Resistance	<20 mOhm
Screw Terminals:	
Maximum Wire Size	20AWG
Recommended Insulation	PFA
Additional Cable Clamp	Yes (in backshell)

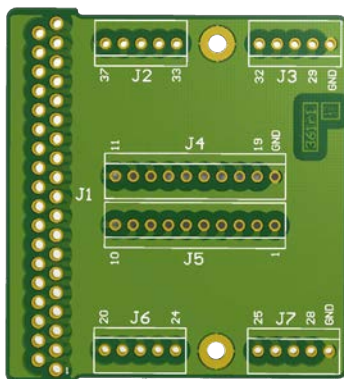

PCB Legend

This Connector Block is Not Suitable for Connection to a Pickering Switching Product

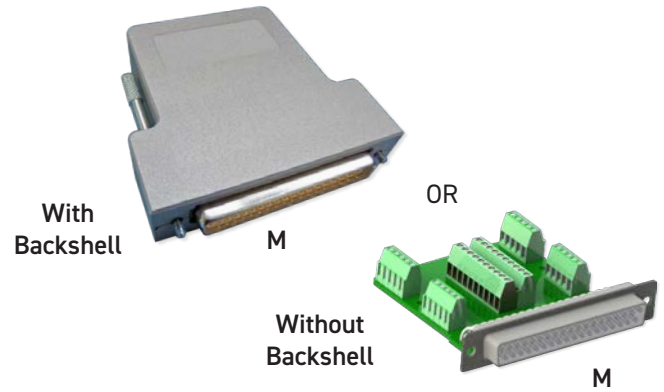

37-Pin D-Type Connector Block

Product Compatibility

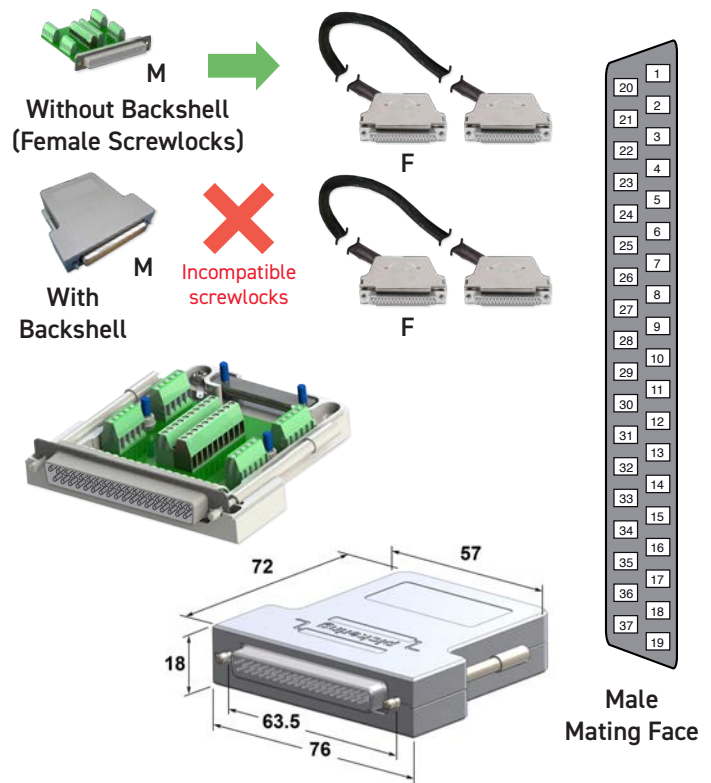

Connector Block Dimensions

Product Order Codes

37-Pin D-Type Connector Block, 5 A, Screw Terminal,
 With Backshell, Male [40-965-037-M](tel:40-965-037-M)
 Without Backshell, Male [92-965-037-M](tel:92-965-037-M)

Note: Male and female screwlocks are provided for connector blocks without a backshell.

- Connector only or Connector and Backshell
- Male Screwlocks
- Cable Clamp in Backshell
- Soldered Cable Termination

This accessory is designed to allow users to directly terminate with soldered connections to the connector.

Connector and shell are supplied separately to allow the user to determine the direction of the cable exit.

When the product is used without a backshell users should make their own cable strain relief arrangements and ensure appropriate electrical safety precautions are observed.

Technical Specification

Connector Type:	37-Pin D-Subminiature
Gender	Male
Securing Method:	
Product with Backshell	4-40 UNC screwlocks, male
Product without Backshell	4-40 UNC screwlocks, male
Wire Connection	Solder bucket. A backshell fixing is also provided for a cable screen
Connector Ratings:	
Maximum Current	5 A
Maximum Voltage	250 VAC
Cable Exit:	45°
Cable Exit Size	13 mm dia
Overall Size (Approx)	H70 x W18.5 x D55 mm
37-Pin D-Sub:	
Contact Material	Gold plated copper alloy
Contact Resistance	20 mOhm
Wire Connection:	
Maximum Wire Size	20AWG
Recommended Insulation	PFA
Additional Cable Clamp	Yes (in backshell)

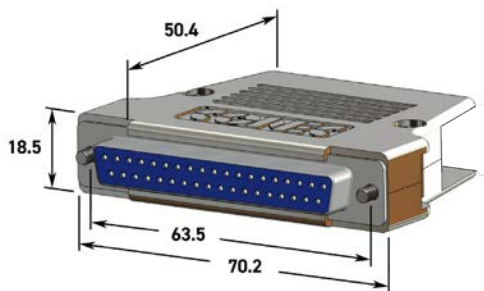

Backshell Dimensions

This Connector is Not Suitable for Connection to a Pickering Switching Product



M

37-Pin D-Type Connector with Backshell

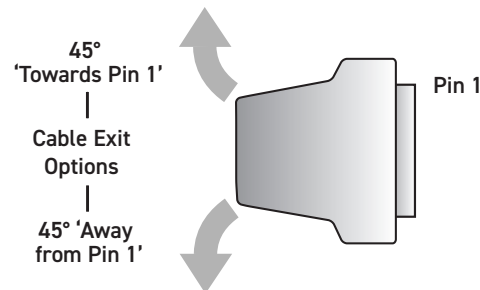

Internal Solder Connection

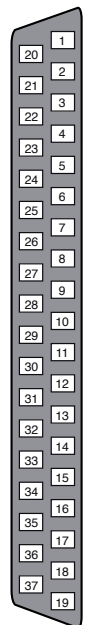

Male Mating Face

Product Order Codes

37-Pin D-Type Connector, 5 A, Solder Bucket, With Backshell, Male	40-960-037-M
Without Backshell, Male	92-960-037-M

Custom Termination

Pickering Interfaces are able to manufacture custom built cable assemblies and backshells that mate with all the connectors we use in our extensive product range and to provide connection solutions for third party products.

We are able to model and manufacture cable assemblies and other termination arrangements to user notes and drawings, and to deal with simple and complex assemblies, and both small and high volume orders.

All products are designed to ensure easy and problem free connection.

We offer a fast turn round of custom items to keep your ordering and integration time scales to a minimum.



Pickering's Cable Design Tool

Our Cable Design Tool is an online tool that allows you to define a cable assembly to exactly meet your requirements.

- Graphical design of customized cable assemblies
- Built-in library of standard cable sets can be used as the basis for customization, or cables can be defined from scratch
- The ability to store cable assemblies in the Cloud and develop them over time
- Each cable design has a PDF documentation file detailing all the specifications
- Allows detailed design including; connector types, wire type, pin definitions, pin & cable labelling, cable bundling, length selection, sleeving, comments, etc.
- Add your own connectors and wires
- Fully supported on major tablet operating systems

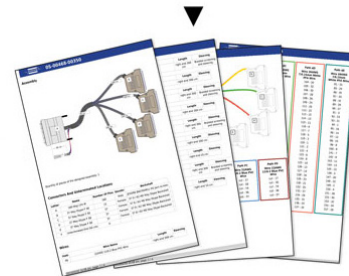
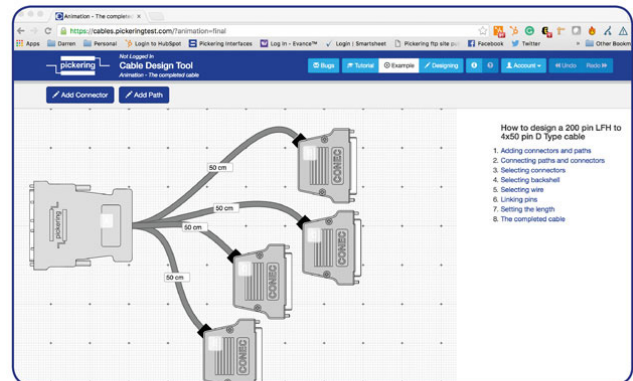

Because the Cable Design Tool is a web-based tool, we will continually update it to better accommodate your requirements and features. Your data is not trapped; complete details of the design are always available to the user at any time via the documentation or spreadsheet file. Once a cable is designed, you can submit it to us for quotation.

For more information visit: pickeringtest.com/cdt