

- Gigabit Ethernet Interface
- Accepts More Than 1000 Pickering Interfaces PXI 3U Switch and Simulation Modules
- Accepts most Pickering Interfaces 3U PXI Instrumentation Modules
- Applications From Simple Switching to RF, Microwave and Optical
- Front Panel IP Address Display
- Low Audible Operating Noise
- 3 Year Warranty



The 60-103B is compliant with the LXI Standard 1.4 and supports Pickering Interfaces 3U PXI switching and simulation modules as though they are an LXI compliant device, complete with a driverless soft front panel. The 60-103B supports up to 18 off 3U modules and is equivalent to a 19 slot PXI chassis.

The chassis allows all switching and simulation 3U PXI modules from Pickering and most† instrumentation products (such as digital I/O, attenuators, power supplies) to be installed and controlled through an Ethernet interface. It is supplied with a built-in generic IVI driver to control the modules in accordance with the LXI specification, but can also be controlled through a kernel driver.

Modules available for installation cover a large variety of functions including switches, matrices and multiplexers capable of switching μA up to 40 A. RF, microwave and optical switches are supported as well as some instrument functions such as variable resistor modules. For more information on compatible PXI modules, please refer to the 60-103B User Manual.

The Ethernet interface enables the chassis to be controlled through a LAN connection with a front panel display showing the IP address. The chassis allows the remote operation of switching modules over long distances including world wide networks. The separation of the chassis from the controller's PCI bus simplifies power-on sequencing of systems and provides independence from the migration of the Windows and VISA environment.

| Pickering's Range of PXI & PXIe Chassis | | | |
|-----------------------------------------|-------|--------------|-----------|
| Chassis Type | Slots | Chassis Size | Model No. |
| PXI | 8 | 4U Full Rack | 40-908 |
| PXI | 14 | 4U Full Rack | 40-914 |
| PXI | 19 | 4U Full Rack | 40-923A |
| PXI | 8 | 4U Half Rack | 40-924 |
| PXIe Hybrid (Gen 3) | 8 | 4U Half Rack | 42-924 |
| PXIe Hybrid (Gen 3) | 18 | 4U Full Rack | 42-925 |
| PXIe Hybrid (Gen 2) | 18 | 4U Full Rack | 42-926 |
| PXI with LXI Control | 7 | 4U Half Rack | 60-102C |
| PXI with LXI Control | 18 | 4U Full Rack | 60-103B |
| PXI with LXI/USB Control | 2 | 1U Half Rack | 60-104 |
| PXI with LXI/USB Control | 4 | 2U Half Rack | 60-105 |
| PXI with LXI/USB Control | 6 | 1U Full Rack | 60-106 |

The compact 4U height of the 60-103B allows efficient use of rack space. Three fans ensure maximum module cooling and an efficient direct convection design allows operation over an extended temperature range.

The 60-103B can be configured over its LXI compliant interface using any standard web browser. The interface can be used to load soft front panels for the installed modules, so they can be manually accessed without the need for drivers on the controller.

† For the compatibility of Pickering's PXI modules other than switching or simulation functions, please check the module's data sheet.

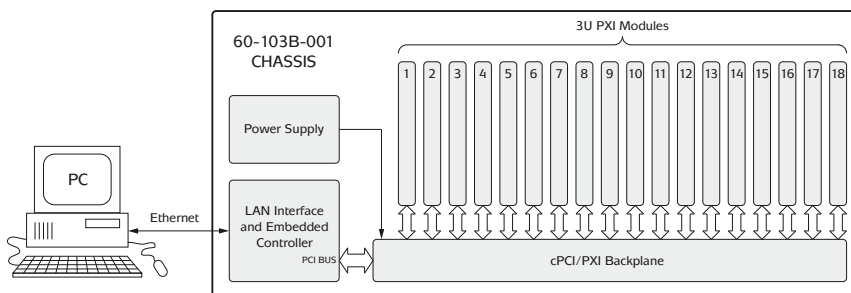

Plugging Pickering Interfaces PXI modules into the 60-103B LXI Modular Switching Chassis provides an LXI compliant switching platform. A simple Ethernet lead is the only physical control connection required.

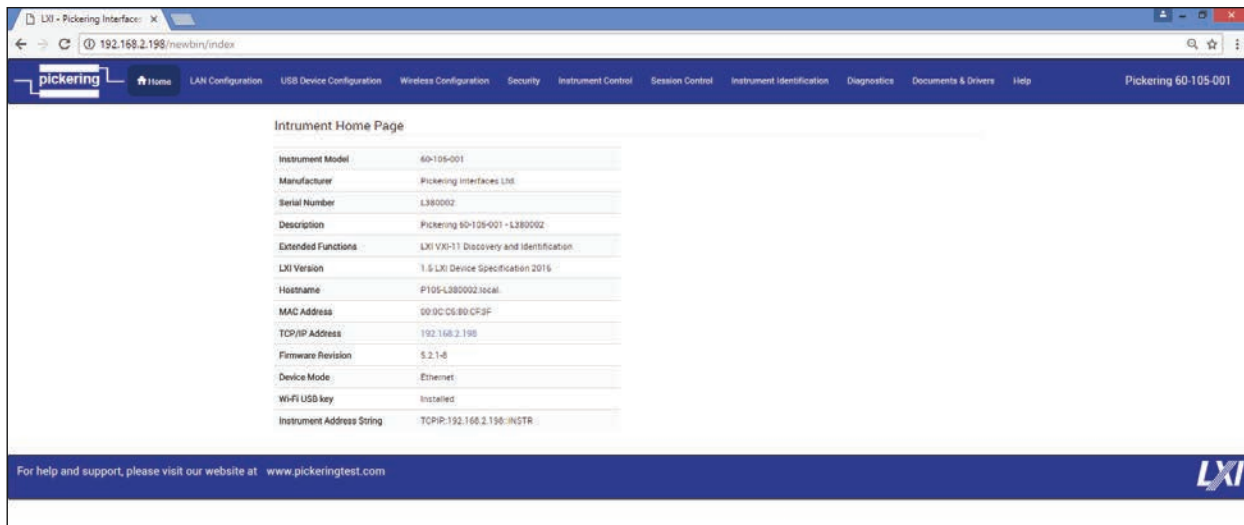

Example home page for a Modular Chassis - provides fast access to configuration information for the chassis through any web browser.

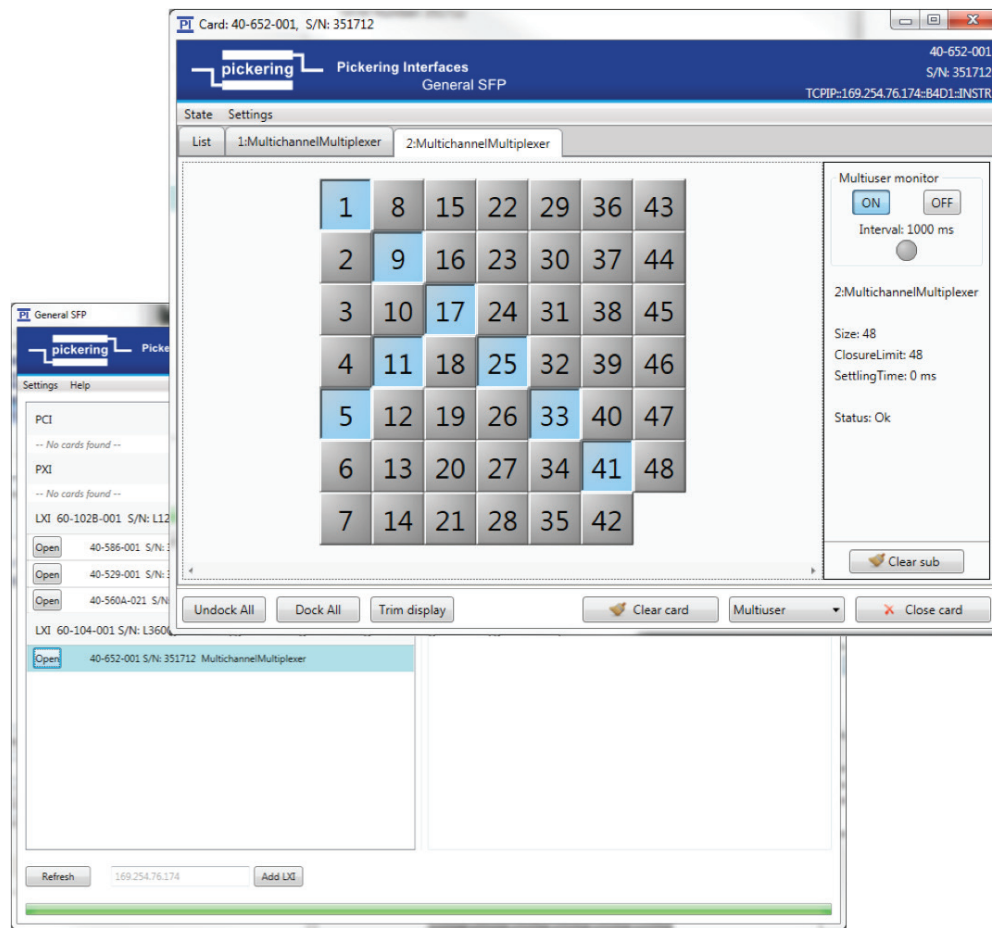

Example General Soft Front Panel - The 60-103B provides soft front panels to enable manual operation of PXI modules.

Specifications

| | |
|--------------------|---------------------------------------------------------------------------------------------------------------------------|
| Chassis Backplane: | 64 bit backplane, compliant with cPCI/PXI specification. Provides trigger, local bus support (subject to module support). |
| Chassis Capacity: | 18 off 3U user slots available. |

PXI Module compatibility

| | |
|--------------------------------------------------------------------------------------------------------------------------------------------------------------------------------------------------------------------------------------------------------------------------------------------------------------|-------------------------------------------------------------------------------------------------------------------------------------------------------------------------|
| The chassis is supplied with drivers for Pickering PXI (System 40) switching modules and selected instrument modules. | |
| Switching Support: | All of 3U Pickering Interface's PXI switching modules. Includes (but not limited to): All BRIC modules , reed relay solutions, EMR modules, RF and optical switches. |
| Instrumentation support: | Programmable resistor and potentiometer modules, RF attenuators, battery simulators, programmable power supplies and digital I/O modules. |
| Soft Front Panel: | All supported PXI modules can be controlled through a W3C compliant web browser. |
| For a selection guide on the range of modules capable of being hosted by the 60-103B chassis, please see the PXI Module Selection Guide in the LXI Product Guide. This is available as a download from the On-Line Catalogs section of our website: pickeringtest.com | |

Power Supply

| | |
|--------------------------|-----------------------------|
| Input Voltage Range: | 90 - 264 VAC |
| Input Voltage Frequency: | 47 to 63 Hz |
| Input Current Rating | 12 A 115 VAC or 6 A 230 VAC |

Integrated power supply with the following capacity for the user modules:

| | | | | |
|-------------|--------|------|-------|--------|
| DC Output | +3.3 V | +5 V | +12 V | -12 V |
| Max Current | 42 A | 45 A | 15 A | 4.75 A |

Cooling

| | |
|----------------------------|------------------------------------------------|
| Airflow: | Bottom intake, top exhaust |
| Per-slot Cooling Capacity: | 25 W at 55 °C ambient 40 W at 40 °C ambient |
| Fans: | 3 off 185.9 cfm fan |

Monitoring

| | |
|----------------------------|-----------------------------------------------------------------------|
| LXI Interface Status LEDs: | Power, Ready, Error, LAN, 100BaseT, 1000BaseT |
| Chassis Status LEDs: | Power, Temperature, Fan Speed |
| Web Page Monitoring: | Chassis air temperature, Backplane supply voltage levels, Fan speeds. |

LAN Interface

| | |
|------------------------------------------------------|---------------------|
| Designed to comply with the LXI Standard Version 1.4 | |
| Connector: | RJ45 Connector |
| Connection Speed: | 1000BaseT interface |

Other Connectors

| |
|--------------------------------------------------------------------------------------------------------------------------------------------------------------------------------------|
| Rear panel Diagnostics Port on 9 pin D connector, front panel Aux connection on USB style connector. Neither connection is intended for normal use, see manual for more information. |
|--------------------------------------------------------------------------------------------------------------------------------------------------------------------------------------|

Supporting Documentation

| |
|-------------------------------------------------------------------------------------------------------------------------------------------------|
| Manuals, drivers and a copy of the short form catalog are stored internally and are accessible through any browser compliant with W3C standards |
|-------------------------------------------------------------------------------------------------------------------------------------------------|

Mechanical Specification

| | |
|-------------|----------------------------------------------------------------------------------------------------------------------------------------------------------------------|
| Dimensions: | Width: 444 mm (17.48") Height: 178 mm (7.01") Depth: 455 mm (17.91") For rack mounting, recommended to be mounted in 5U to allow free bottom intake of air. |
| Weight: | 13.8 kg (30.4 lbs) without PXI modules |

Operating/Storage Conditions

| | |
|-----------------------------------|---------------------------|
| Operating Conditions: | |
| Operating Temperature: | 0 °C to +55 °C |
| Humidity: | 10% to 95% non-condensing |
| Storage and Transport Conditions: | |
| Storage Temperature: | -20 °C to +70 °C |
| Humidity: | 10% to 90% non-condensing |

Safety, CE & RoHS Compliance

All products are fully CE compliant and meet applicable EU directives:

Low-voltage safety EN61010-1:2010,

EMC Immunity EN61326-1:2013,

Emissions EN55011:2009+A1:2010.

The 60-103B Chassis also complies with the European Restriction of Hazardous Substances directive (RoHS).

Product Order Codes

| | |
|--------------------------------------|-------------|
| LXI Modular Chassis, 18-Slot | 60-103B-001 |
| Optional 19" rack mounting hardware* | 63-103-001 |

* Please refer to the 60-103B User Manual for information on the optional chassis mounting hardware.

PXI Switching and Sensor Simulation

Pickering is a leading manufacturer of PXI switching and sensor simulation modules, available in PXI and PXIe formats. With our deep portfolio of over 1,000 modules, we provide the assurance that you can optimize your test system switching and simulation to exactly fit your needs. These modules range from the highest density switching matrices, RF/Microwave and optical switching, to sensor simulation, including programmable resistors, strain gauge, battery and thermocouple simulators.

Please refer to the categories below and visit pickeringtest.com/pxi to find the products you need:

Sensor Simulation

- Programmable Resistors
- Thermocouple Simulators
- LVDT/RVDT/Resolver Simulators
- Analog Output/Current Loop Simulators
- Strain Gauge Simulators
- Digital I/O and Prototype
- Power Supply & Battery Simulators
- Amplifier & Attenuator
- Waveform Generator
- Switch Simulators

Switching

- General Purpose Relay
- BRIC™ Large Matrices
- Matrices
- Multiplexers
- RF & Microwave
- Fault Insertion
- USB, Comms, Avionics & Optical
- 6U Switching

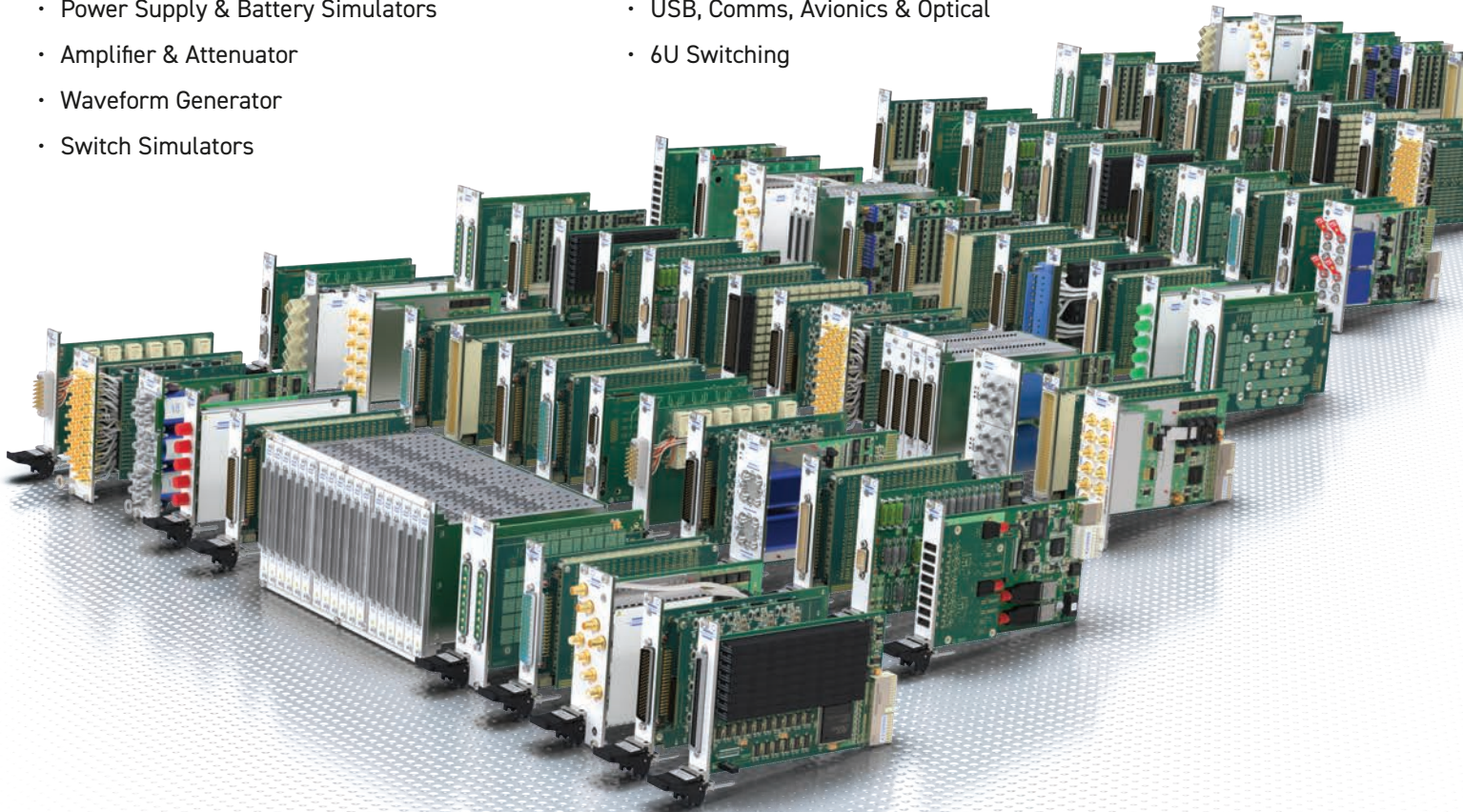

All of our PXI modules will plug into any PXI compliant chassis or a Hybrid Slot in a PXIe chassis and may also be used in our Ethernet controlled modular LXI switching chassis. Our PXIe modules will plug into any compliant PXIe slot or Hybrid Slot in a PXIe chassis.

Connectivity Solutions

We provide a full range of supporting cable and connector solutions for all our switching products—20 connector families with 1200+ products. We offer everything from simple mating connectors to complex cables assemblies and terminal blocks. All assemblies are manufactured by Pickering and are guaranteed to mechanically and electrically mate to our modules. These accessories are detailed in Connector Accessories data sheets, where a complete list and documentation can be found for each accessory.



Connectors & Backshells



Multi-way Cable Assemblies

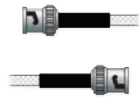

RF Cable Assemblies



Breakouts



Connector Blocks

We also offer customized cabling and have a free online **Cable Design Tool** that can be used to create custom cable solutions for many applications.

- Fully supported on modern browsers and tablet operating systems.
- Built-in tutorials and videos allow you to get quickly up to speed.
- Store cable assemblies in the Cloud and develop over time.
- Each cable design has a downloadable PDF documentation file detailing all specifications

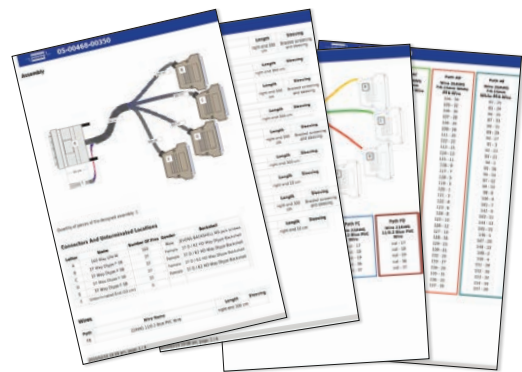

Start designing your custom cabling, go to pickeringtest.com/cdt

Mass Interconnect

We recommend the use of a mass interconnect solution when an Interchangeable Test Adapter (ITA) is required for PXI/LXI based test systems. Our modules are fully supported by Virginia Panel and MacPanel.

Pickering Reed Relays

We are the only switch provider with in-house reed relay manufacturing capability via our Relay Division. These instrument grade reed relays feature **SoftCenter™** technology, ensuring long service life and repeatable contact performance.

To learn more go to pickeringrelay.com

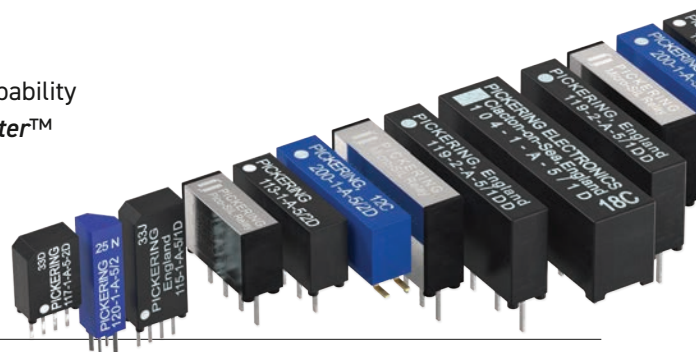

Programming

Pickering provide kernel, IVI and VISA (NI & Keysight) drivers which are compatible with all Microsoft supported versions of Windows and popular older versions.

For more information go to pickeringtest.com/os

The VISA driver support is provided for LabVIEW Real Time Operating Systems (Pharlap and Linux-RT). For other RTOS support contact Pickering. These drivers may be used with a variety of programming environments and applications including:

- **Pickering Interfaces Switch Path Manager**
- **National Instruments products** (LabVIEW, LabWindows/CVI, Switch Executive, MAX, TestStand, VeriStand, etc.)
- **Microsoft Visual Studio products** (Visual Basic, Visual C++)
- **Programming Languages C, C++, C#, Python**
- **Keysight VEE and OpenTAP**
- **Mathworks MATLAB, Simulink**
- **Marvin ATEasy**
- **MTQ Testsolutions Tecap Test & Measurement Suite**

Drivers for popular Linux distributions are available, other environments are also supported, please contact Pickering with specific enquiries. We provide Soft Front Panels (SFPs) for our products for familiarity and manual control, as well as comprehensive documentation and example programs to help you develop test routines with ease.

To learn more about software drivers and development environments go to pickeringtest.com/software

Signal Routing Software

Our signal routing software, Switch Path Manager, automatically selects and energizes switch paths through Pickering switching systems. Signal routing is performed by simply defining test system endpoints to be connected together, greatly accelerating Test System software development.

To learn more go to pickeringtest.com/spm

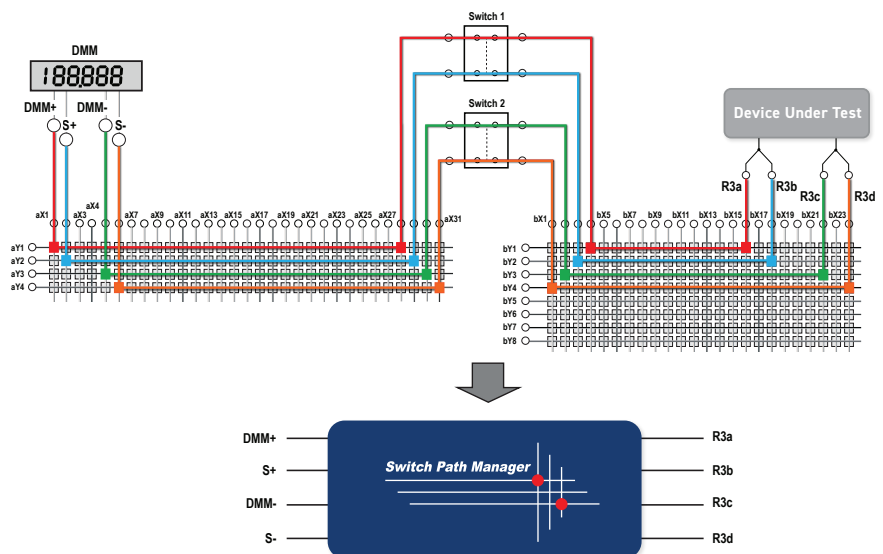

Diagnostic Relay Test Tools

eBIRST Switching System Test Tools are designed specifically for our PXI, PCI or LXI products, these tools simplify switching system fault-finding by quickly testing the system and graphically identifying the faulty relay.

To learn more go to pickeringtest.com/ebirst



Three Year Warranty & Guaranteed Long-Term Support

All standard products manufactured by Pickering Interfaces are warranted against defective materials and workmanship for three years from the date of delivery to the original purchaser. Extended warranty and service agreements are available with various levels for your requirements. Although we offer a 3-year warranty as standard, we also include guaranteed long-term support—with a history of supporting our products for typically 15-20 years.

To learn more go to pickeringtest.com/support

Available Product Resources

We have a library of resources including success stories, product and support videos, articles and white papers as well as application-specific brochures to assist you. We have also published reference books on switching technology and the PXI and LXI standards.

To view, download or request any of our product resources go to pickeringtest.com/resources

