

- DC to 10MHz
- Three Channels in One 3 U Slot
- 48-bit Frequency Resolution
- Simple Generation of Repetitive Arbitrary Waveforms
- DC Offset Capability
- Flexible Sweep Capability
- Amplitude Modulation Capability
- Uses 10 MHz PXI Clock, Internally Generated Clock or External Clock Reference
- Comprehensive Trigger Support
- VISA Driver Supplied for Windows
- Supported by PXI or LXI Chassis
- 3 Year Warranty



The 41-620A is a compact 3 channel function generator in a PXI 3U single slot module. It is capable of generating sine waves to 10 MHz with 48-bit frequency resolution referenced to the 10 MHz PXI clock, a high stability internal 10 MHz clock or to an external standard. It can generate arbitrary waveforms loaded into the internal 256 k memory, allowing emulation of many signal types, including the typical waveforms of automotive and aerospace sensors.

The function generator has a very simple method of providing variable output frequencies through the use of Direct Digital Synthesis (DDS), making it far easier to use than an ARB for repetitive waveform generation.

It is capable of generating fast swept frequencies, allowing the emulation of variable speed devices. Sweeps can be single shot events or continuous up and down ramps. DDS technology ensures the settling time is extremely fast, limited only by the update time via the PXI bus.

Each channel can be amplitude modulated from a single AM input connector to allow independent time varying output levels to be produced. One channel of the module can be externally connected to provide the time varying level control independently of the waveform being generated.

Waveforms for the function generator are stored in independent 256 k memory blocks, allowing each channel to provide a different signal. Waveforms are easily created externally, using Excel or similar tools, and loaded into the module's memory via the backplane. When 2 or 3 channels are set to generate periodic waveforms of the same frequency with continuous trigger, they can be phase aligned via a single command.

PXI trigger functions are supported allowing events from other instruments to initiate waveform generation or sweeps.

The supplied soft front panel allows quick generation of common waveforms and the importing of external waveforms. It also supports swept modes of operation.

The 41-650 high voltage amplifier is perfect partner to the 41-620A, allowing the generated signal levels to be boosted to 60 Vpp.

**Note:** The 41-620A is backwardly compatible with the 41-620 in performance, functionality and driver.

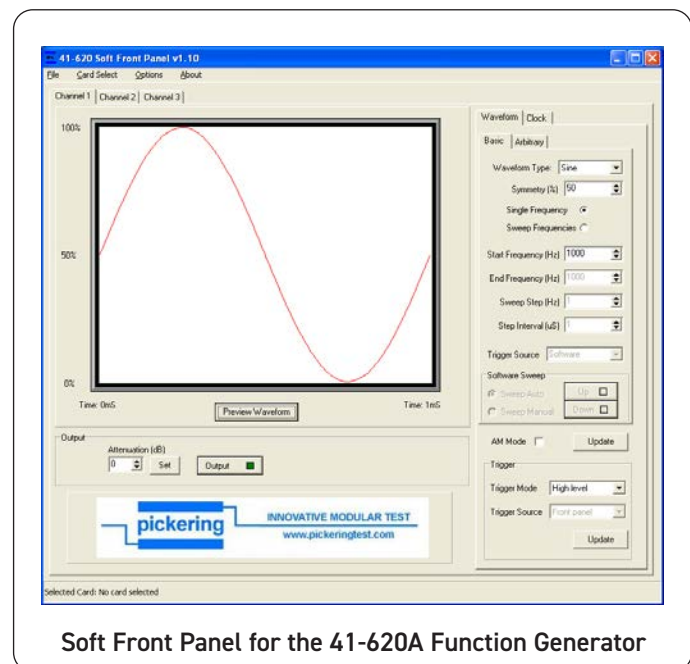

Soft Front Panel for the 41-620A Function Generator

## Typical Waveforms Generated by 41-620A With Output Attenuation at 10 dB and Loaded into 50 Ω

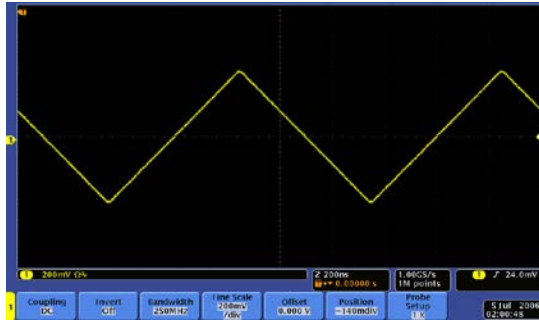

Triangular Waveform at Frequency of 1 MHz

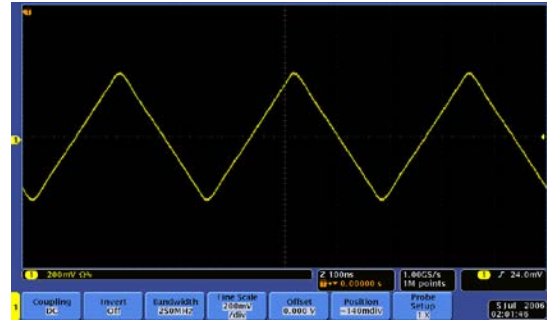

Triangular Waveform at Frequency of 3 MHz

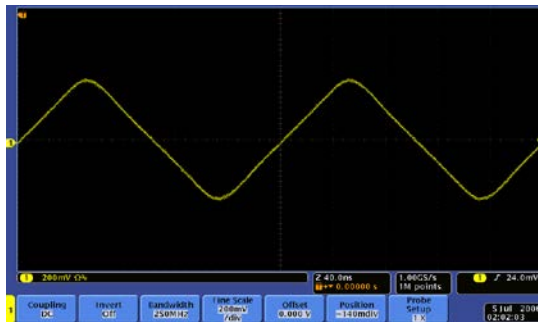

Triangular Waveform at Frequency of 5 MHz

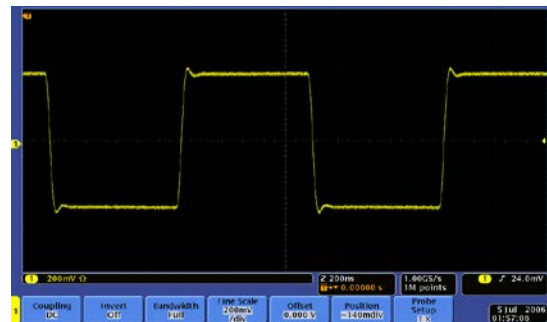

Square Wave at Frequency of 3 MHz

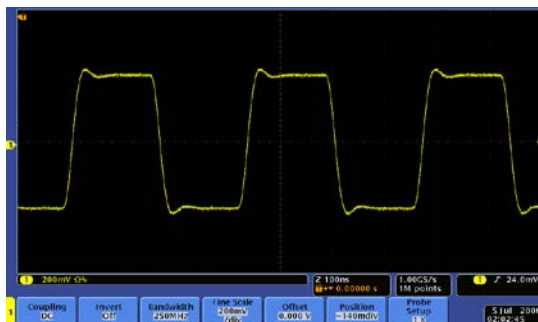

Square Wave at Frequency of 5 MHz

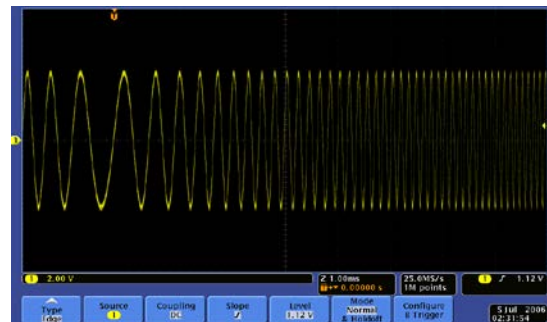

Swept Sine Wave from 1 kHz to 10 kHz in 10 Hz Steps at 10 μs Intervals

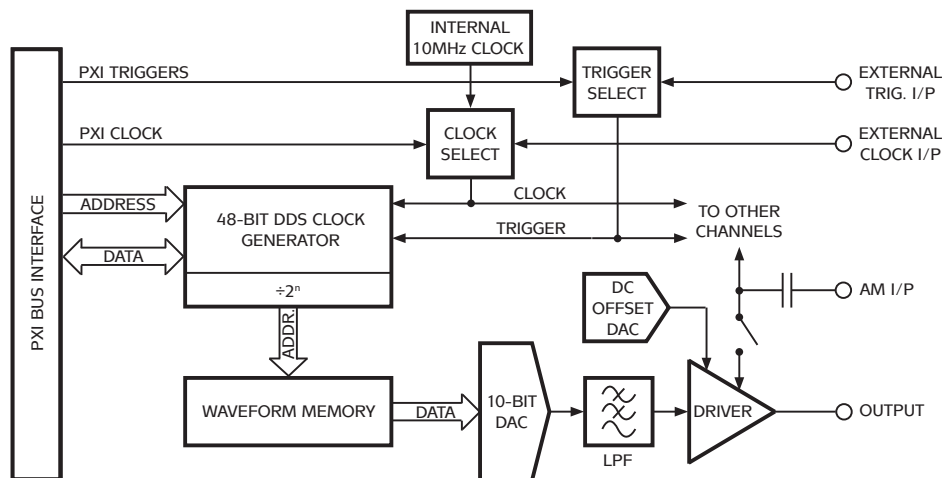

41-620A Function Generator Block Diagram

## Specification (each channel)

### Frequency

Frequency range:	DC to 10 MHz (sine wave)
Frequency resolution:	48-bit
Frequency accuracy:	As PXI backplane / external 10 MHz clock or 10 ppm if internal source selected.
Frequency sweep:	Frequency sweeps can be single or continuous (ramp up and/or down) phase continuous through use of DDS sweep facility.

### Output

Maximum Output:	±10 V, open circuit load.
Waveform Signal:	10 V pk to pk, open circuit load
Output Offset Voltage:	Settable from -5 V to +5 V in 10mV steps
Output DAC Resolution:	10-bit
Signal Level Control:	0 to -40 dB, <0.1 dB steps.
Output Impedance:	50 Ω
Output Loading:	Capable of driving 600 Ω with 10 V peak EMF. Typically capable of driving a 50 Ω load with 6 V peak EMF output (DC & signal).

### AM Input

Functionality:	Single input connection can be used to amplitude one, two or three output channels. AC coupled, modulation frequency range 10 Hz to 20 kHz.
----------------	---

### Waveforms

Waveform memory:	256 k per channel of fixed length. Permits any waveform to be loaded and replayed, including sine, square, ramp. Waveform fidelity limited by fixed 15 MHz low pass filter.
------------------	---

### Parametric Performance

(AM and DC offset set to 0)	
SFDR:	>40 dB (DC to 1 MHz, 5 Vpp) >35 dB (1 MHz to <10 MHz, 5 Vpp) >25 dB @ 10 MHz (5 Vpp)
Amplitude accuracy:	±2% DC to 1 MHz 0 to -15% (typically -8%) at 10 MHz

### Trigger and Clock

Clock source:	10 MHz PXI clock, internal clock or external clock source.
Trigger:	Level or edge triggered. Initiates single shot or continuous operation PXI trigger sources or external source.
Level:	Clock and trigger inputs require DC coupled signal derived from 5 V CMOS logic drivers, nominal +2.5 V input threshold voltage.

### Power Requirements

+3.3V	+5V	+12V	-12V
1.8 A	110 mA	75 mA	150 mA

### Mechanical Characteristics

Single slot 3U PXI (CompactPCI) instrument module. 3D models for all versions in a variety of popular file formats are available on request.

### Connectors

PXI bus via 32-bit P1/J1 backplane connector. Signals via front panel SMB connectors.

### Operating/Storage Conditions

#### Operating Conditions

Operating Temperature:	0°C to +55°C
Humidity:	Up to 90% non-condensing
Altitude:	5000 m

#### Storage and Transport Conditions

Storage Temperature:	-20°C to +75°C
Humidity:	Up to 90% non-condensing
Altitude:	15000 m

### PXI & CompactPCI Compliance

The module is compliant with the PXI Specification 2.2. Local Bus, Uses a 33 MHz 32-bit backplane interface.

### Safety & CE Compliance

All modules are fully CE compliant and meet applicable EU directives: Low-voltage safety EN61010-1:2010, EMC Immunity EN61326-1:2013, Emissions EN55011:2009+A1:2010.

## Product Order Codes

**PXI Three Channel Function Generator 41-620A-003**

## Latest Details

Please refer to [pickeringtest.com](http://pickeringtest.com) for latest product details.

## Product Customization

Pickering modules are designed and manufactured on our own flexible manufacturing lines, giving complete product control and enabling simple customization to meet very specific requirements.

All customized products are given a unique part number, fully documented and may be ordered at any time in the future. Please contact your local sales office to discuss.

## Mating Connectors & Cabling

For connection accessories for the 41-620A module please refer to the [90-011D](#) RF Cable Assemblies data sheet where a complete list and documentation can be found for accessories, or refer to the Connection Solutions catalog.

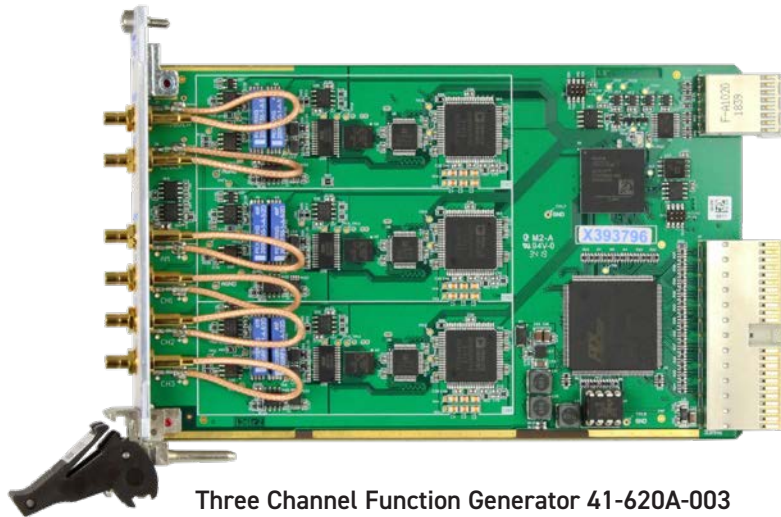

Three Channel Function Generator 41-620A-003

## Chassis Compatibility

This PXI module must be used in a suitable chassis. It is compatible with the following chassis types:

- All chassis conforming to the 3U PXI and 3U Compact PCI (cPCI) specification
- Legacy and Hybrid Peripheral slots in a 3U PXI Express (PXIe) chassis
- Pickering Interfaces LXI or LXI/USB Modular Chassis

## Chassis Selection Guide

### Standard PXI or hybrid PXIe Chassis from any Vendor:

- Mix our 1000+ PXI switching & simulation modules with any vendor's PXI instrumentation
- Embedded or remote Windows PC control
- Real-time Operating System Support
- High data bandwidths, especially with PXI Express
- Integrated module timing and synchronization



### Pickering LXI or LXI/USB Modular Chassis—only accept our 1000+ PXI Switching & Simulation Modules:

- Ethernet or USB control enables remote operation
- Low-cost control from practically any controller
- LXI provides manual control via Web browsers
- Driverless software support
- Power sequencing immunity
- Ethernet provides chassis/controller voltage isolation
- Independence from Windows operating system



## Connectivity Solutions

We provide a full range of supporting cable and connector solutions for all our switching products—20 connector families with 1200+ products. We offer everything from simple mating connectors to complex cables assemblies and terminal blocks. All assemblies are manufactured by Pickering and are guaranteed to mechanically and electrically mate to our modules.



Connectors & Backshells



Multiwire Cable Assemblies

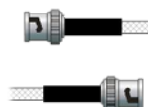

RF Cable Assemblies



Connector Blocks

We also offer customized cabling and have a free online **Cable Design Tool** that can be used to create custom cable solutions for many applications. Visit: [pickeringtest.com/cdt](http://pickeringtest.com/cdt) to start your design.

## Mass Interconnect

We recommend the use of a mass interconnect solution when an Interchangeable Test Adapter (ITA) is required for a PXI or LXI based test system. Our modules are fully supported by both Virginia Panel and MacPanel.



## Pickering Reed Relays

We are the only switch provider with in-house reed relay manufacturing capability via our Relay Division. These instrument grade reed relays feature **SoftCenter™** technology, ensuring long service life and repeatable contact performance. To learn more, please go to: [pickeringrelay.com](http://pickeringrelay.com)



## Programming

Pickering provide kernel, IVI and VISA (NI & Keysight) drivers which are compatible with all Microsoft supported versions of Windows and popular older versions. For a list of all supporting operating systems, please see: [pickeringtest.com/os](http://pickeringtest.com/os)

The VISA driver is also compatible with Real-Time Operating Systems such as LabVIEW RT. For other RTOS support contact Pickering. These drivers may be used with a variety of programming environments and applications including:

- **Pickering Interfaces Switch Path Manager**
- **National Instruments** products (LabVIEW, LabWindows/CVI, Switch Executive, MAX, TestStand, VeriStand, etc.)
- **Microsoft Visual Studio** products (Visual Basic, Visual C+)
- **Keysight** VEE and OpenTAP
- **Mathworks** Matlab
- **Marvin** ATEasy
- **MTQ Testsolutions** Tecap Test & Measurement Suite

Drivers for popular Linux distributions are available, other environments are also supported, please contact Pickering with specific enquiries. We provide Soft Front Panels (SFPs) for our products for familiarity and manual control, as well as comprehensive documentation and example programs to help you develop test routines with ease.

To learn more about software drivers and development environments, please go to: [pickeringtest.com/software](http://pickeringtest.com/software)

## Signal Routing Software

Our signal routing software, Switch Path Manager, automatically selects and energizes switch paths through Pickering switching systems. Signal routing is performed by simply defining test system endpoints to be connected together, greatly accelerating Test System software development. To learn more, please go to: [pickeringtest.com/spm](http://pickeringtest.com/spm)

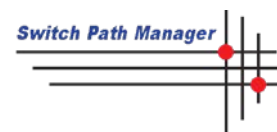

## Diagnostic Relay Test Tools

**eBIRST** Switching System Test Tools are designed specifically for our PXI, PCI or LXI products, these tools simplify switching system fault-finding by quickly testing the system and graphically identifying the faulty relay.

To learn more, please go to: [pickeringtest.com/ebirst](http://pickeringtest.com/ebirst)



## Three Year Warranty & Guaranteed Long-Term Support

All standard products manufactured by Pickering Interfaces are warranted against defective materials and workmanship for a period of three years from the date of delivery to the original purchaser. Extended warranty and service agreements are available for all our modules and systems with various levels to suit your requirements. Although we offer a 3-year warranty as standard, we also include guaranteed long-term support—with a history of supporting our products for typically 15-20 years. To learn more, please go to: [pickeringtest.com/support](http://pickeringtest.com/support)

## Available Product Resources

We have a large library of product resources including success stories, product and support videos, articles and white papers as well as application specific product brochures to assist when looking for the switching, simulation and connection solutions you need. We have also published handy reference books on Switching Technology and for the PXI and LXI standards.



To view, download or request any of our product resources, please visit: [pickeringtest.com/resources](http://pickeringtest.com/resources)