

- Available as PXI or PXIe Modules
- Single or Dual SP4T or SP6T Panel Mounted Multiplexer
- Up To 3 Remote SP4T or SP6T Multiplexers From Single Slot Version
- 50  $\Omega$  Versions With 3-67 GHz Bandwidth
- 50  $\Omega$  Terminated and unterminated versions
- 75  $\Omega$  Version With 2.5 GHz Bandwidth
- Relay Cycle Counting Included
- LED Indication
- VISA, IVI & Kernel Drivers Supplied for Windows
- PXI Version Supported by PXI or LXI Chassis
- 3 Year Warranty



The 40-785C (PXI) and 42-785C (PXIe) range of PXI microwave multiplexer modules are suitable for switching 50  $\Omega$  signals up to 67 GHz. They are available in single or dual SP4T or SP6T configurations with relays mounted on the front panel. Remote versions are also available which can support up to three multiplexers in a single slot.

The remote multiplexer versions, as well as occupying less PXI panel space, allow the microwave relays to be placed closer to the UUT and RF test equipment. This can shorten the length of cables and improve system performance. Remote versions are supplied with a 1.5 m interface cable.

The panel mounted 50  $\Omega$  terminated version occupies 3 slots for the single version or 6 slots for the dual version. A 75  $\Omega$  version is available with a bandwidth of 2.5 GHz and uses Siemens 1.6/5.6 style connectors.



Single slot version controls 1, 2 or 3 remotely mounted multiplexers via interface cables

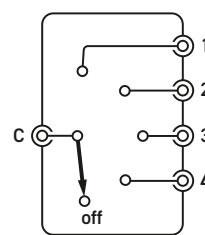

Single Unterminated SP4T

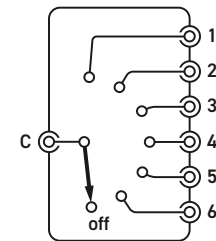

Single Unterminated SP6T

## Microwave Multiplexer (Part No. 4x-785C) in Single Unterminated Format

The 4x-785C range is suitable for constructing complex microwave switching networks and includes configurations to suit most applications. Connection is by high performance SMA, SMA 2.9, SMA 2.4, SMA 1.85 or N-type for 50  $\Omega$  versions. These modules give you the highest RF and microwave performance available within a Pickering switching system. Although designed for microwave applications, they have many uses in the RF spectrum where extremely low insertion loss and ultra high isolation are critical.

## Product Compatibility

The 4x-785C range has been introduced as an update to the existing 40-785B family. These remain orderable but the new 4x-785C is recommended as it provides additional options such as the PXIe control interface. The RF performance of the 4x-785C is identical to the 40-785B.

Issue 3.0 October 2023

## Relay Cycle Counting

To aid with module "health" monitoring all versions are provided with a relay cycle counting feature. The number of operations per contact are stored on the module and can be used to determine if a relay is approaching EOL. This information could allow system connections to be revised so that signals applied to heavily used contacts are swapped with lightly used contacts to prolong the working life of the relay(s).

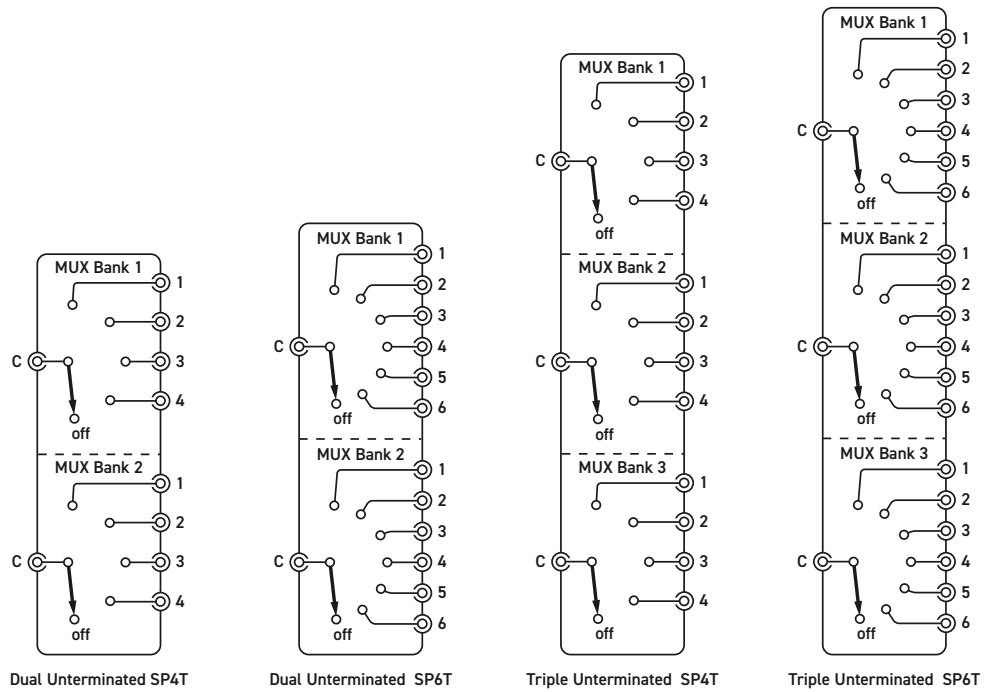

**4x-785C Underterminated Multiplexer Range (triple versions are only available in remote mount format)**

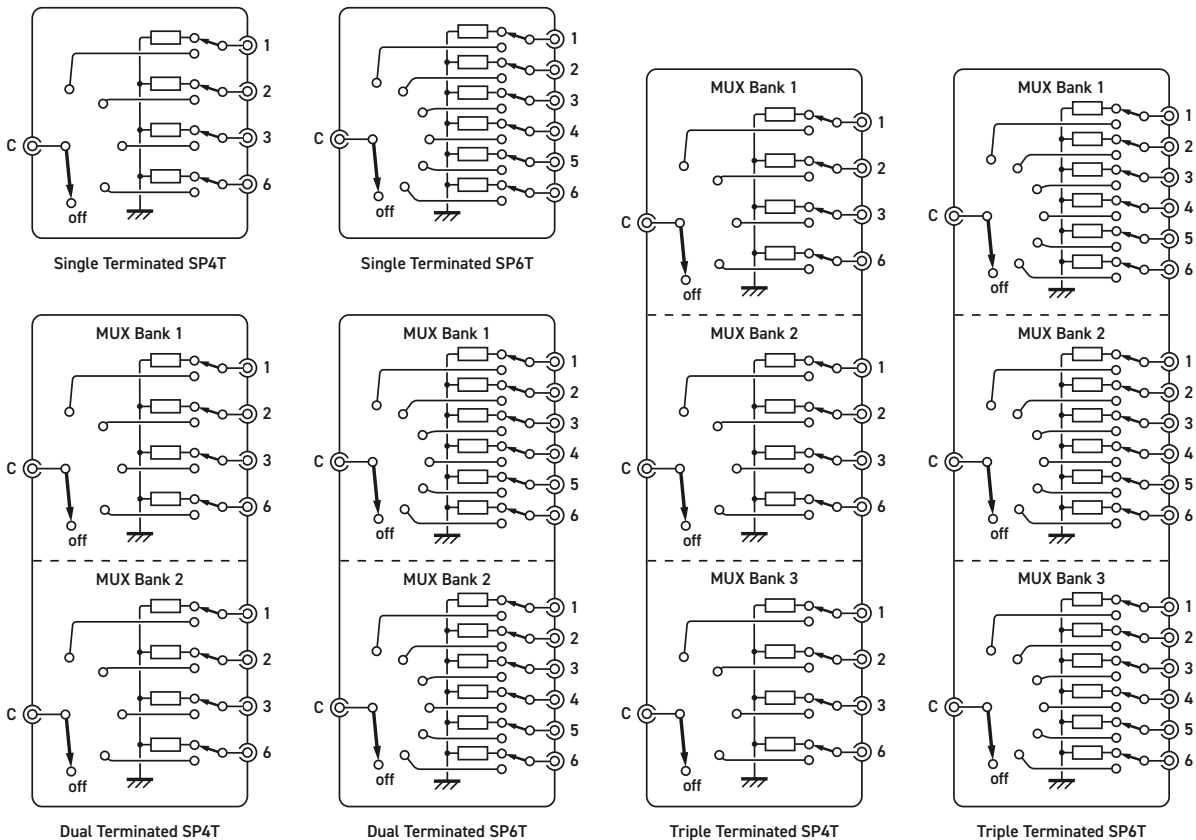

**4x-785C Terminated Multiplexer Range (triple versions are only available in remote mount format)**

## Remotely Mounted Microwave Multiplexer Versions

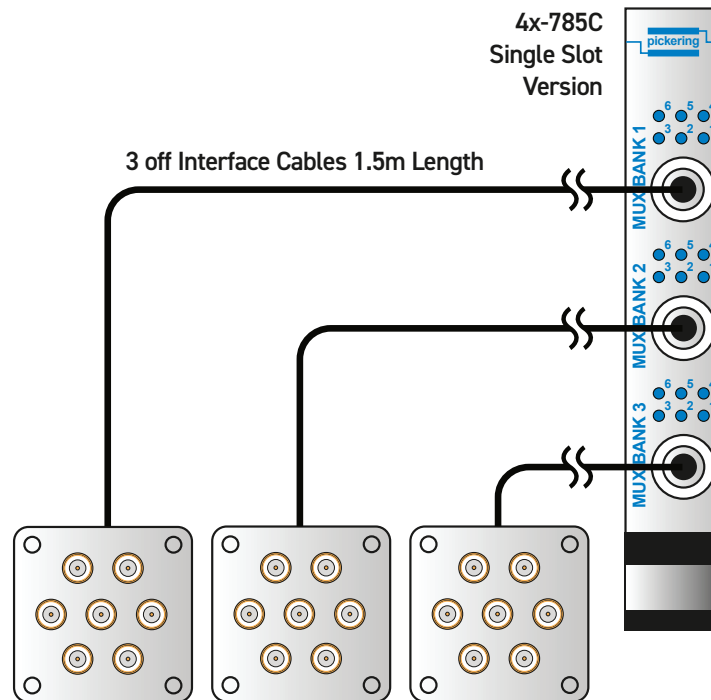

Remotely Mounted Microwave Multiplexers

Interconnection Between 4x-785C Single Slot Version and Remotely Mounted Microwave Multiplexers



### Remote Mount Microwave Multiplexer (18-67 GHz) Range:

- Upper left, unterminated (all frequencies) relay.
- Upper right, terminated 26.5 GHz, 40 GHz or 50 GHz relay.
- Lower left, unterminated (all frequencies) relay mounted to optional bracket.
- Lower right, terminated 26.5 GHz, 40 GHz or 50 GHz relay mounted to optional bracket.

## General Multiplexer Information

Relay Manufacturer:	Radiall
Configuration:	SP6T or SP4T Microwave MUX with 1, 2 or 3 independent banks.
LED Indicators:	Multiplexers have blue LEDs to indicate a closed RF path.
Operate Time:	Typically 15 ms
Maximum Cold Switch Voltage:	100 V
Maximum Carry Current:	1 A

## 3 GHz Unterminated & Terminated Versions

Characteristic Impedance:	50 $\Omega$
Connectors:	N-type
Bandwidth	DC to 3 GHz
Isolation:	80 dB (0-3 GHz)
Insertion Loss:	0.2 dB (0-3 GHz)
VSWR:	1.2:1 (0-3 GHz)
Maximum RF Carry Power:	400 W (0-3 GHz)
Termination Power Rating:	1 W per termination, 3 W total per 6 channel multiplexer.
Expected Life (Low Power):	3 GHz option, >2 million operations 3 GHz terminated option, >2 million operations

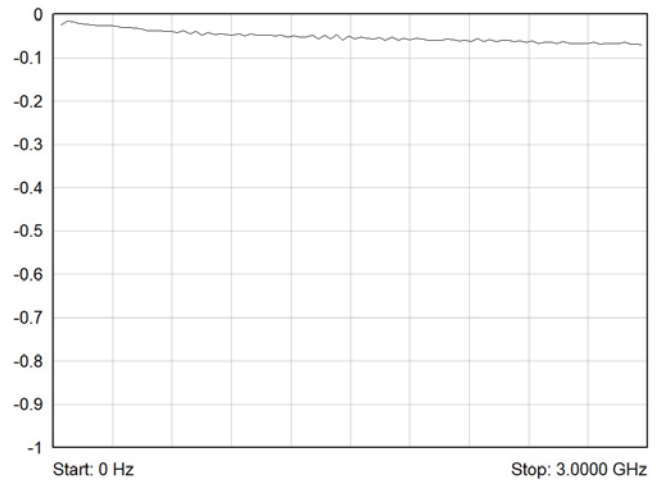

Typical Insertion Loss (dB) - 3 GHz Terminated & Unterminated Versions

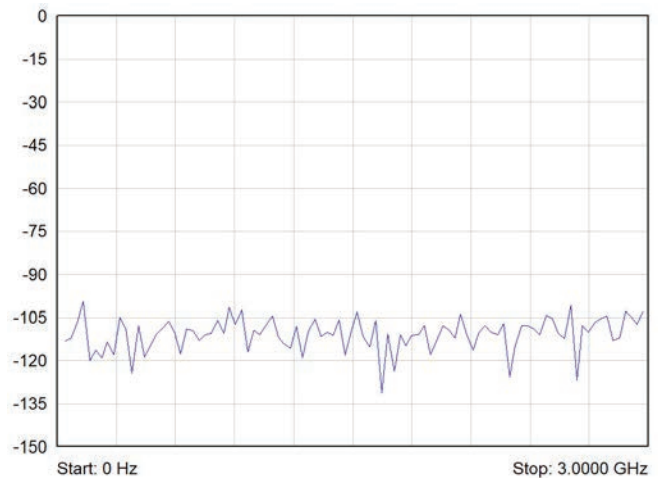

Typical Isolation (dB) - 3 GHz Terminated & Unterminated Versions

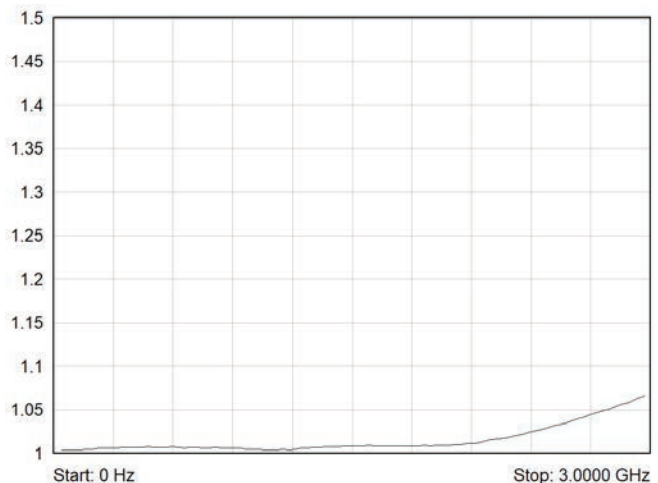

Typical VSWR - 3 GHz Terminated & Unterminated Versions

## 18 GHz Underterminated & Terminated Versions

Characteristic Impedance:	50 $\Omega$
Connectors:	SMA
Bandwidth	DC to 18 GHz
Isolation:	80 dB (0-3 GHz) 70 dB (3-8 GHz) 60 dB (8-12.4 GHz) 60 dB (12.4-18 GHz)
Insertion Loss:	0.2 dB (0-3 GHz) 0.3 dB (3-8 GHz) 0.4 dB (8-12.4 GHz) 0.5 dB (12.4-18 GHz)
VSWR:	1.2:1 (0-3 GHz) 1.3:1 (3-8 GHz) 1.4:1 (8-12.4 GHz) 1.5:1 (12.4-18 GHz)
Maximum RF Carry Power:	240 W (0-3 GHz) 150 W (3-8 GHz) 120 W (8-12.4 GHz) 100 W (12.4-18 GHz)
Termination Power Rating:	1 W per termination, 3W total per 6 channel multiplexer.
Expected Life (Low Power):	18 GHz option >5 million operations 18 GHz terminated option >2 million operations

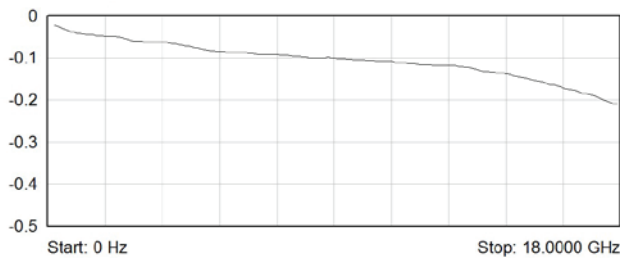

Typical Insertion Loss (dB) - 18 GHz Underterminated Versions

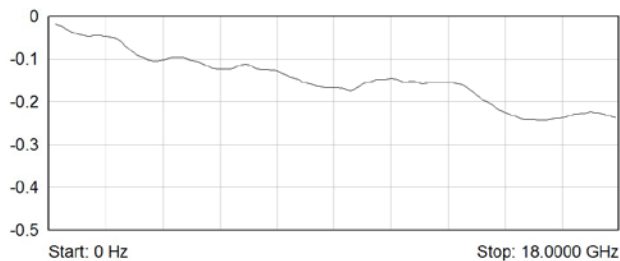

Typical Insertion Loss (dB) - 18 GHz Terminated Versions

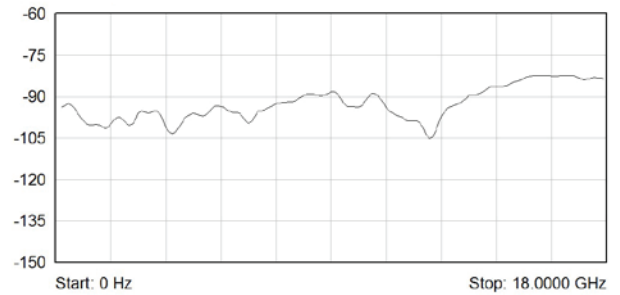

Typical Isolation (dB) - 18 GHz Underterminated Versions

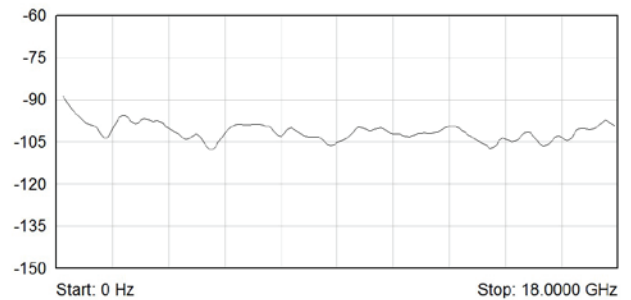

Typical Isolation (dB) - 18 GHz Terminated Versions

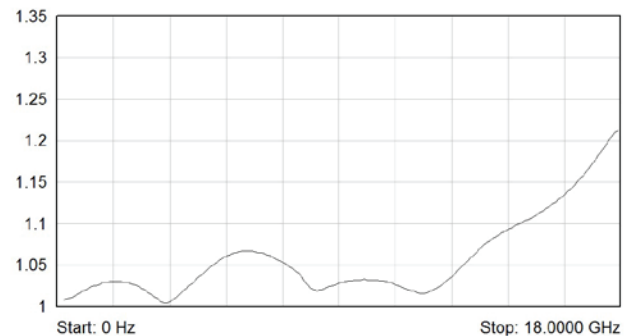

Typical VSWR - 18 GHz Underterminated Versions

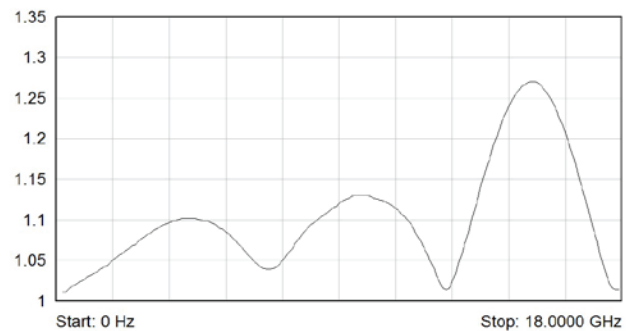

Typical VSWR - 18 GHz Terminated Versions

## 26.5 GHz Underterminated Versions

Characteristic Impedance:	50 $\Omega$
Connectors:	SMA
Bandwidth	DC to 26.5 GHz
Isolation:	80 dB (0-3 GHz) 70 dB (3-8 GHz) 60 dB (8-12.4 GHz) 60 dB (12.4-18 GHz) 50 dB (18-26.5 GHz)
Insertion Loss:	0.2 dB (0-3 GHz) 0.3 dB (3-8 GHz) 0.4 dB (8-12.4 GHz) 0.5 dB (12.4-18 GHz) 0.7 dB (18-26.5 GHz)
VSWR:	1.2:1 (0-3 GHz) 1.3:1 (3-8 GHz) 1.4:1 (8-12.4 GHz) 1.5:1 (12.4-18 GHz) 1.7:1 (18-26.5 GHz)
Maximum RF Carry Power:	240 W (0-3 GHz) 150 W (3-8 GHz) 120 W (8-12.4 GHz) 100 W (12.4-18 GHz) 40 W (18-26.5 GHz)
Expected Life (low power):	5 million ops per position

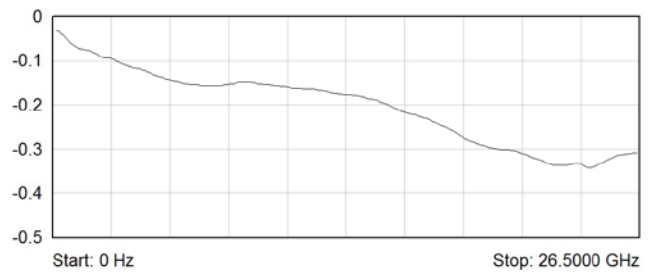

Typical Insertion Loss (dB) - 26.5 GHz Underterminated Versions

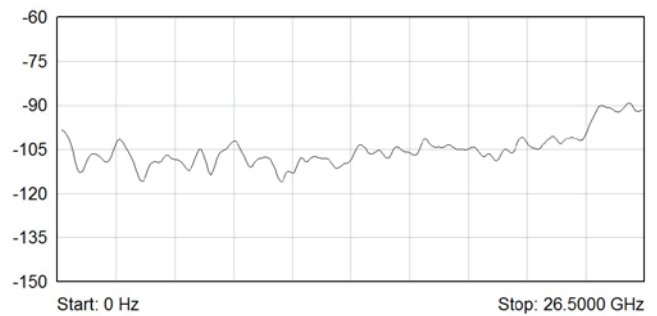

Typical Isolation (dB) - 26.5 GHz Underterminated Versions

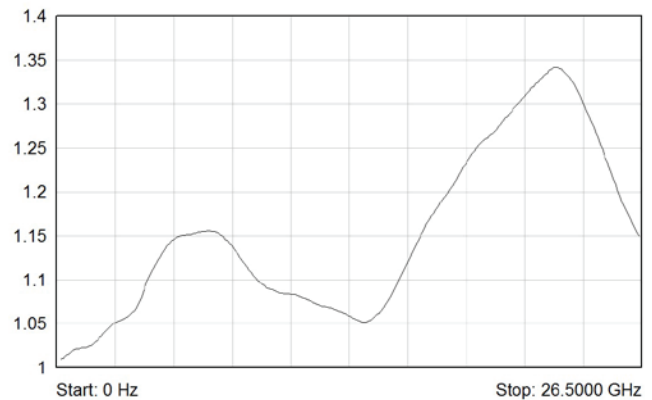

Typical VSWR - 26.5 GHz Underterminated Versions

## 26.5 GHz Terminated Versions

Characteristic Impedance:	50 $\Omega$
Connectors:	SMA
Bandwidth	DC to 26.5 GHz
Isolation:	80 dB (0-3 GHz) 70 dB (3-8 GHz) 60 dB (8-12.4 GHz) 60 dB (12.4-18 GHz) 55 dB (18-26.5 GHz)
Insertion Loss:	0.2 dB (0-3 GHz) 0.3 dB (3-8 GHz) 0.4 dB (8-12.4 GHz) 0.5 dB (12.4-18 GHz) 0.7 dB (18-26.5 GHz)
VSWR:	1.2:1 (0-3 GHz) 1.3:1 (3-8 GHz) 1.4:1 (8-12.4 GHz) 1.5:1 (12.4-18 GHz) 1.7:1 (18-26.5 GHz)
Maximum RF Carry Power:	240 W (0-3 GHz) 150 W (3-8 GHz) 120 W (8-12.4 GHz) 100 W (12.4-18 GHz) 40 W (18-26.5 GHz)
Termination power rating:	1 W per termination, 3 W total per 6 channel multiplexer
Expected Life (low power):	>2 million ops per position

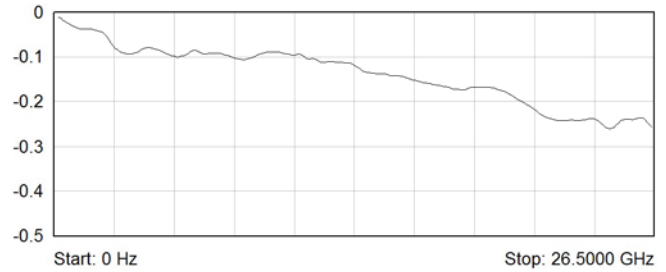

Typical Insertion (dB) Loss - 26.5 GHz Terminated Versions

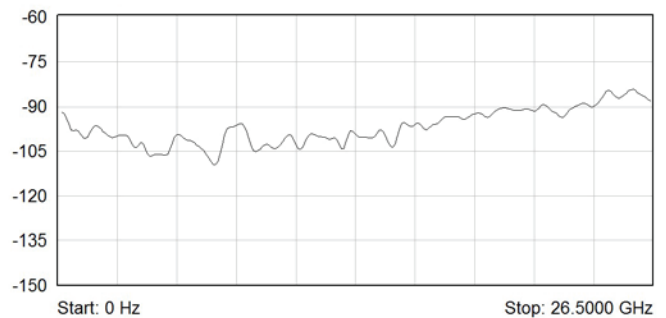

Typical Isolation (dB) - 26.5 GHz Terminated Versions

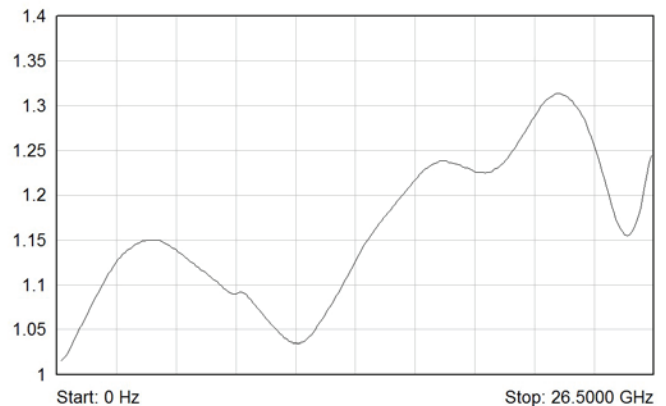

Typical VSWR - 26.5 GHz Terminated Versions



## 40 GHz Unterminated & Terminated Versions

Characteristic Impedance:	50 $\Omega$
Connectors:	SMA 2.9
Bandwidth	DC to 40 GHz
Isolation:	70 dB (0-6 GHz) 60 dB (6-12.4 GHz) 60 dB (12.4-18 GHz) 55 dB (18-26.5 GHz) 50 dB (26.5-40 GHz)
Insertion Loss:	0.2 dB (0-6 GHz) 0.4 dB (6-12.4 GHz) 0.5 dB (12.4-18 GHz) 0.7 dB (18-26.5 GHz) 1.1 dB (26.5-40 GHz)
VSWR:	1.3:1 (0-6 GHz) 1.4:1 (6-12.4 GHz) 1.5:1 (12.4-18 GHz) 1.7:1 (18-26.5 GHz) 2.2:1 (26.5-40 GHz)
Maximum RF Carry Power:	40 W (0-6 GHz) 30 W (6-12.4 GHz) 25 W (12.4-18 GHz) 15 W (18-26.5 GHz) 5 W (26.5-40 GHz)
Termination power rating:	1 W per termination, 3 W total per 6 channel mux
Expected Life (Low Power):	>2 million ops per position

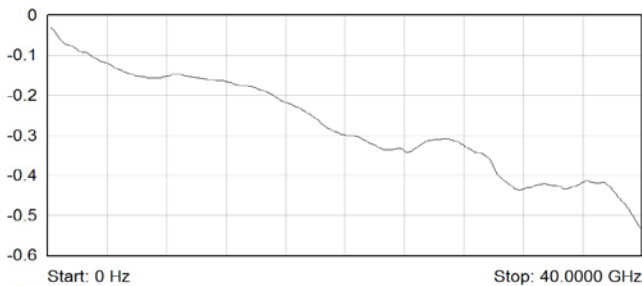

Typical Insertion Loss (dB) - 40 GHz Unterminated Versions

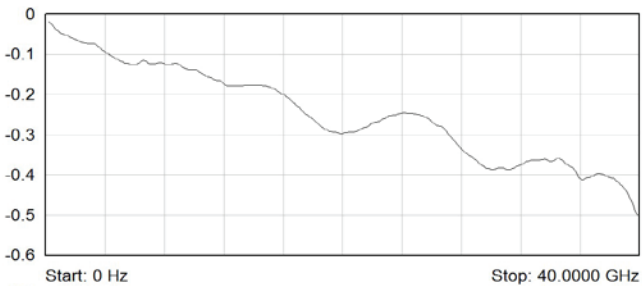

Typical Insertion (dB) Loss - 40 GHz Terminated Versions

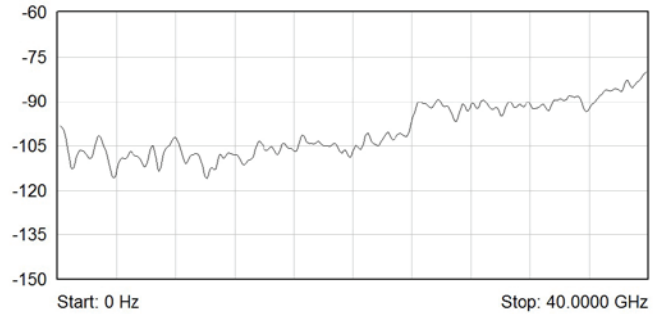

Typical Isolation (dB) - 40 GHz Unterminated Versions

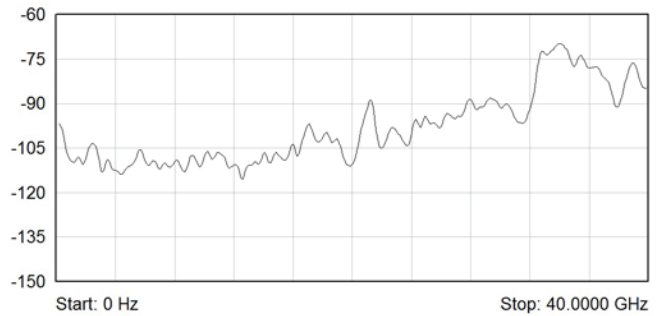

Typical Isolation (dB) - 40 GHz Terminated Versions

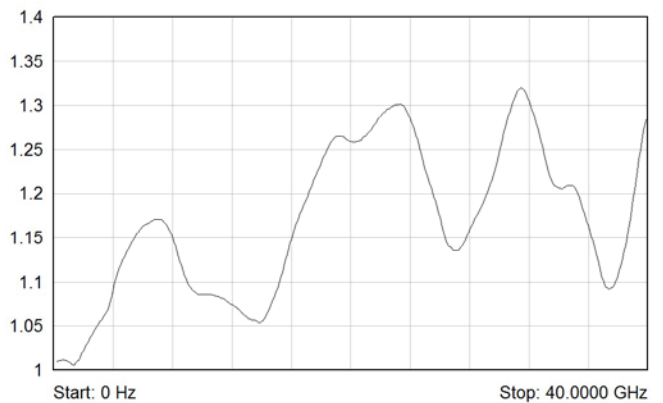

Typical VSWR - 40 GHz Unterminated Versions

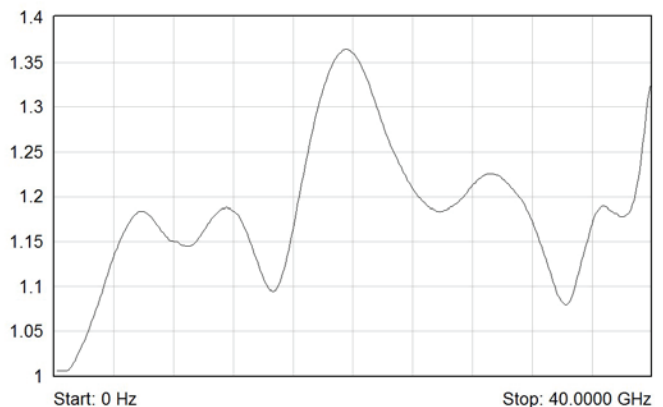

Typical VSWR - 40 GHz Terminated Versions



## 50 GHz Unterminated & Terminated Versions

Characteristic Impedance:	50 $\Omega$
Connectors:	SMA 2.4
Bandwidth	DC to 50 GHz
Isolation:	70 dB (0-6 GHz) 60 dB (6-12.4 GHz) 60 dB (12.4-18 GHz) 55 dB (18-26.5 GHz) 50 dB (26.5-40 GHz) 50 dB (40-50 GHz)
Insertion Loss:	0.2 dB (0-6 GHz) 0.4 dB (6-12.4 GHz) 0.5 dB (12.4-18 GHz) 0.7 dB (18-26.5 GHz) 0.9 dB (26.5-40 GHz) 1.2 dB (40-50 GHz)
VSWR:	1.3:1 (0-6 GHz) 1.4:1 (6-12.4 GHz) 1.5:1 (12.4-18 GHz) 1.7:1 (18-26.5 GHz) 1.9:1 (26.5-40 GHz) 2.2:1 (40-50 GHz)
Maximum RF Carry Power:	40 W (0-6 GHz) 30 W (6-12.4 GHz) 25 W (12.4-18 GHz) 15 W (18-26.5 GHz) 5 W (26.5-40 GHz) 3 W (40-50 GHz)
Termination power rating:	1 W per termination, 3 W total per 6 channel multiplexer
Expected Life (Low Power):	>2 million operations per position

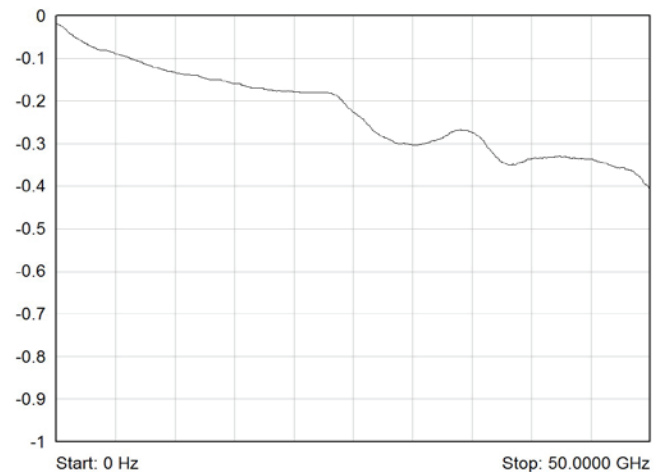

Typical Insertion Loss (dB) - 50 GHz  
Terminated & Unterminated Versions

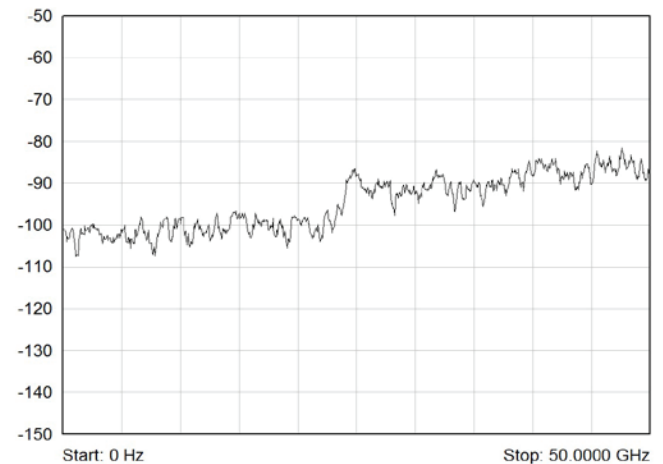

Typical Isolation (dB) - 50 GHz  
Terminated & Unterminated Versions

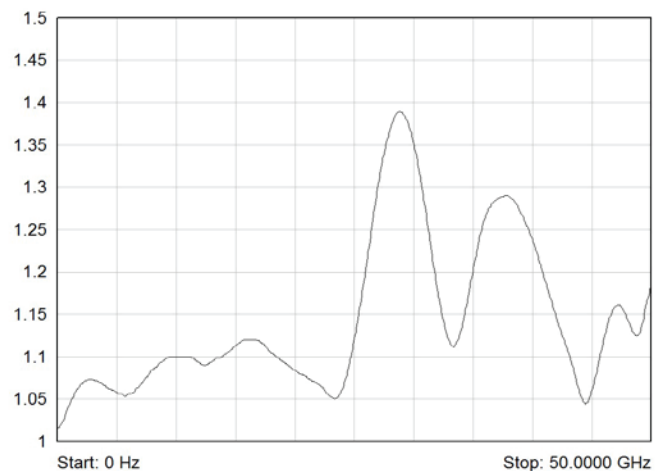

Typical VSWR - 50 GHz Terminated &  
Unterminated Versions

## 67 GHz Underterminated Versions

Characteristic Impedance:	50 $\Omega$
Connectors:	SMA 1.85
Bandwidth	DC to 67 GHz
Isolation:	70 dB (0-6 GHz) 60 dB (6-12.4 GHz) 60 dB (12.4-18 GHz) 55 dB (18-26.5 GHz) 50 dB (26.5-40 GHz) 50 dB (40-50 GHz) 50 dB (50-65 GHz) 50 dB (65-67 GHz)
Insertion Loss:	0.3 dB (0-6 GHz) 0.4 dB (6-12.4 GHz) 0.5 dB (12.4-18 GHz) 0.7 dB (18-26.5 GHz) 0.9 dB (26.5-40 GHz) 1.2 dB (40-50 GHz) 1.2 dB (50-65 GHz) 1.7 dB (65-67 GHz)
VSWR:	1.3:1 (0-6 GHz) 1.4:1 (6-12.4 GHz) 1.5:1 (12.4-18 GHz) 1.7:1 (18-26.5 GHz) 1.9:1 (26.5-40 GHz) 2.2:1 (40-50 GHz) 2.2:1 (50-65 GHz) 2.2:1 (65-67 GHz)
Maximum RF Carry Power:	40 W (0-6 GHz) 30 W (6-12.4 GHz) 25 W (12.4-18 GHz) 15 W (18-26.5 GHz) 5 W (26.5-40 GHz) 3 W (40-50 GHz) 1 W (50-65 GHz) 1 W (65-67 GHz)
Expected Life (Low Power):	>2 million operations per position

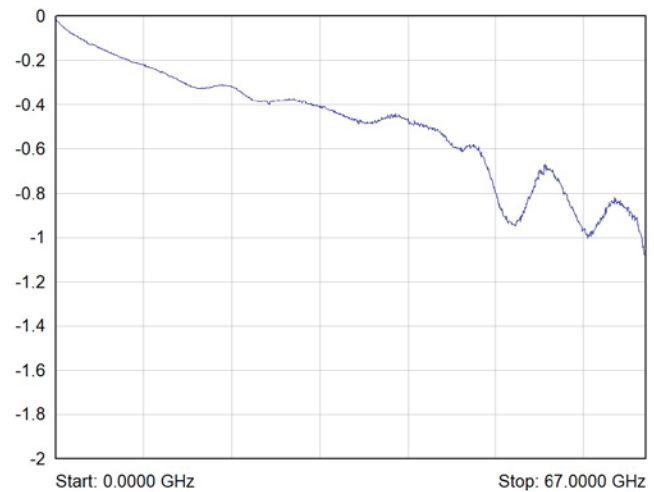

Typical Insertion Loss (dB) - 67 GHz Underterminated Versions

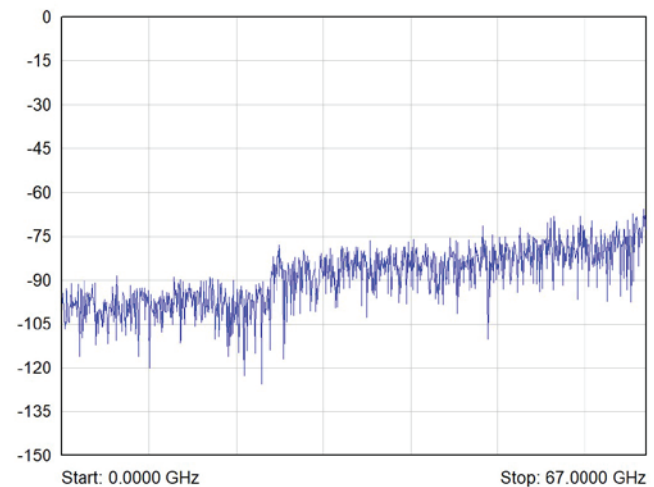

Typical Isolation (dB) - 67 GHz Underterminated Versions

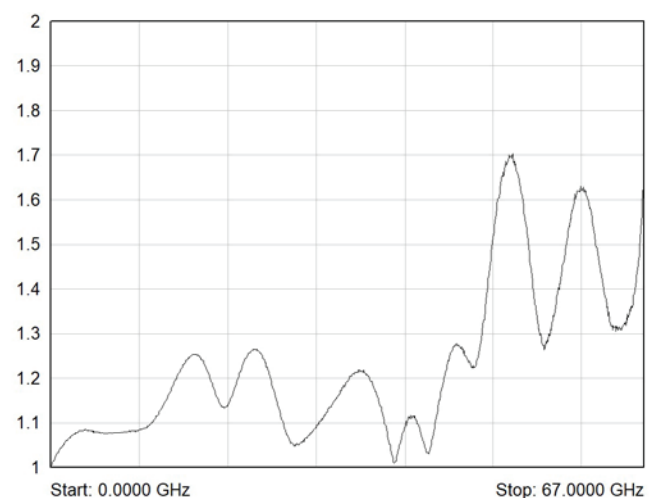

Typical VSWR - 67 GHz Underterminated Versions

## 67 GHz Terminated Versions

Characteristic Impedance:	50 $\Omega$
Connectors:	SMA 1.85
Bandwidth	DC to 67 GHz
Isolation:	70 dB (0-6 GHz) 60 dB (6-12.4 GHz) 60 dB (12.4-18 GHz) 55 dB (18-26.5 GHz) 50 dB (26.5-40 GHz) 50 dB (40-50 GHz) 50 dB (50-65 GHz) 50 dB (65-67 GHz)
Insertion Loss:	0.3 dB (0-6 GHz) 0.4 dB (6-12.4 GHz) 0.5 dB (12.4-18 GHz) 0.7 dB (18-26.5 GHz) 0.9 dB (26.5-40 GHz) 1.2 dB (40-50 GHz) 1.4 dB (50-65 GHz) 1.7 dB (65-67 GHz)
VSWR:	1.3:1 (0-6 GHz) 1.4:1 (6-12.4 GHz) 1.5:1 (12.4-18 GHz) 1.7:1 (18-26.5 GHz) 1.9:1 (26.5-40 GHz) 2.2:1 (40-50 GHz) 2.2:1 (50-65 GHz) 2.2:1 (65-67 GHz)
Maximum RF Carry Power:	40 W (0-6 GHz) 30 W (6-12.4 GHz) 25 W (12.4-18 GHz) 15 W (18-26.5 GHz) 5 W (26.5-40 GHz) 3 W (40-50 GHz) 1 W (50-65 GHz) 1 W (65-67 GHz)
Termination power rating:	1 W per termination, 3 W total per 6 channel multiplexer
Expected Life (Low Power):	>2 million operations per position

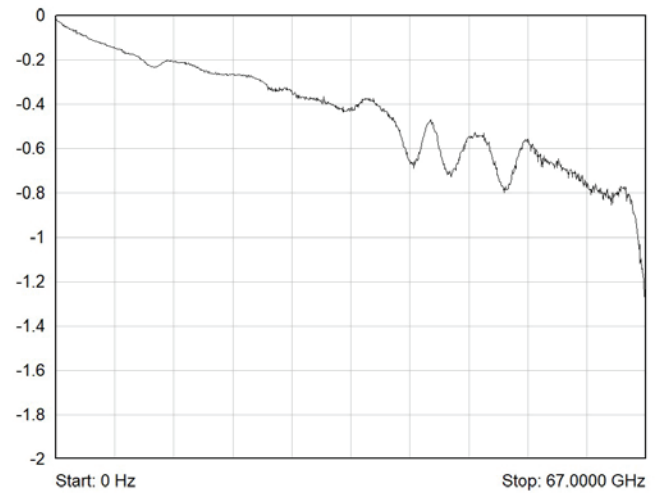

Typical Insertion Loss (dB) - 67 GHz Terminated Versions

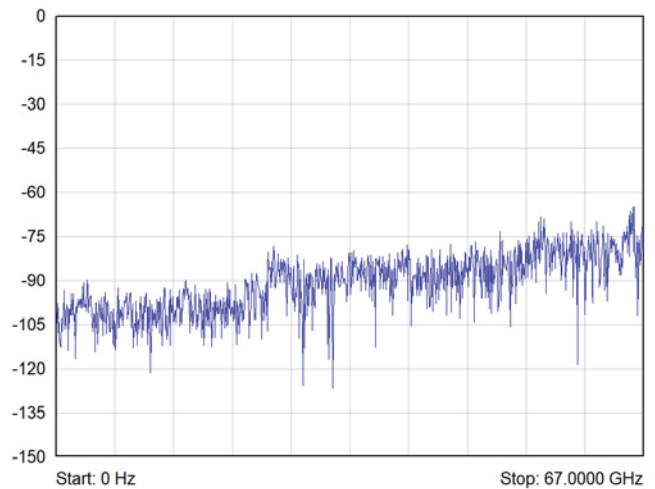

Typical Isolation (dB) - 67 GHz Terminated Versions

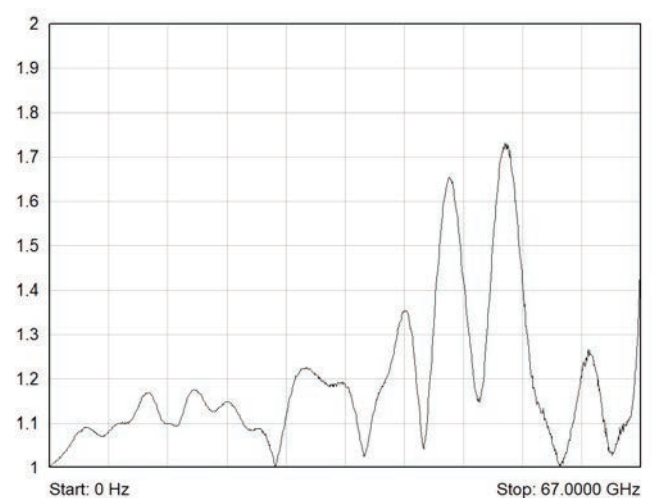

Typical VSWR - 67 GHz Terminated Versions

## 2.5 GHz Unterminated Version

Characteristic Impedance:	75 $\Omega$
Connectors:	1.6/5.6
Bandwidth	DC to 2.5 GHz
Isolation:	80 dB (0-1 GHz) 70 dB (1-2.5 GHz)
Insertion Loss:	0.2 dB (0-1 GHz) 0.3 dB (1-2.5 GHz)
VSWR:	1.2:1 (0-1 GHz) 1.3:1 (1-2.5 GHz)
Maximum RF Carry Power:	400 W (0-1 GHz) 240 W (1-2.5 GHz)
Expected Life (Low Power):	>2 million operations per position

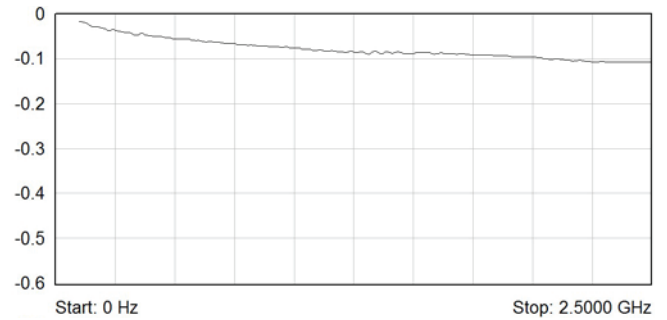

Typical Insertion Loss (dB) - 2.5 GHz 75  $\Omega$  Versions

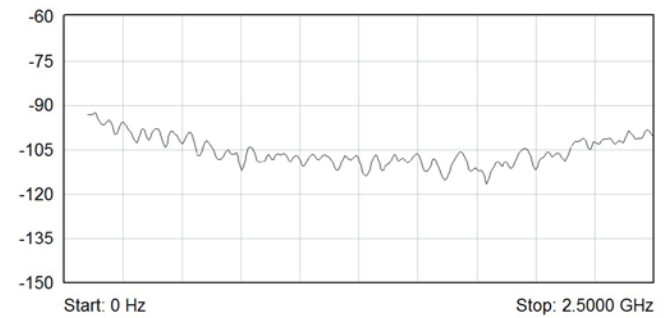

Typical Isolation (dB) - 2.5 GHz 75  $\Omega$  Versions

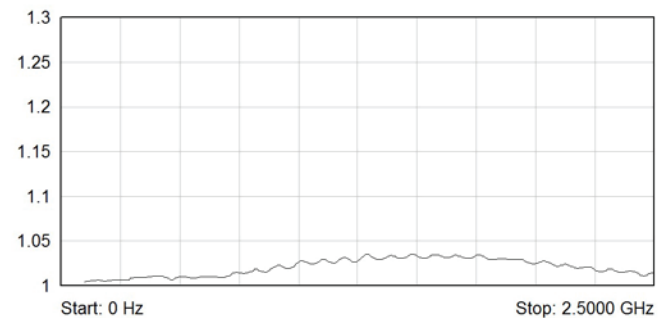

Typical VSWR - 2.5 GHz 75  $\Omega$  Versions

## Mechanical Characteristics

Front panel mounted multiplexers:

- 40-785C Single unterminated versions (except 3 GHz)
  - 3 slot 3U PXI (CompactPCI card)
- 40-785C 3 GHz versions
  - 4 slot 3U PXI (CompactPCI card)
- 40-785C Single terminated versions
  - 3 slot 3U PXI (CompactPCI card)
- 40-785C Dual unterminated versions
  - 3 slot 3U PXI (CompactPCI card)
- 40-785C Dual terminated versions
  - 6 slot 3U PXI (CompactPCI card)
- 42-785C Single unterminated versions (except 3 GHz)
  - 3 slot 3U PXIe, compatible with PXIe hybrid slot
- 42-785C 3 GHz versions
  - 4 slot 3U PXIe, compatible with PXIe hybrid slot
- 42-785C Single terminated versions
  - 3 slot 3U PXIe, compatible with PXIe hybrid slot
- 42-785C Dual unterminated versions
  - 3 slot 3U PXIe, compatible with PXIe hybrid slot
- 42-785C Dual terminated versions
  - 6 slot 3U PXIe, compatible with PXIe hybrid slot

Remote mounted multiplexers:

- 40-785C Remote mounted versions
  - Single slot 3U PXI (CompactPCI card)
- 42-785C Remote mounted versions
  - Single slot 3U PXIe, compatible with PXIe hybrid slot

Remote mounted multiplexer versions are supplied with a 1.5 m interface cable for each of the supplied microwave relays.

3D models for all versions in a variety of popular file formats are available on request.

## Power Requirements - 40-785C

+3.3 V	+5 V	+12 V	-12 V
0.13 A	0.01 A	0.75 A	0

## Power Requirements - 42-785C

+3.3 V	+12 V
0.36 A	0.95 A

## Connectors

40-788 - PXI bus via 32-bit P1/J1 backplane connector.

42-788 - PXIe bus via XJ3 and XJ4 backplane connectors.

Signals via front panel mounted coaxial connectors:

- 3 GHz, 50  $\Omega$  versions - N-type
- 18 GHz, 50  $\Omega$  versions - SMA
- 26.5 GHz, 50  $\Omega$  versions - SMA
- 40 GHz, 50  $\Omega$  versions - SMA-2.9
- 50 GHz, 50  $\Omega$  versions - SMA-2.4
- 67 GHz, 50  $\Omega$  versions - SMA-1.85
- 2.5 GHz, 75  $\Omega$  versions - Siemens 1.6/5.6

## Operating/Storage Conditions

Operating Temperature:	0 °C to +55 °C
Humidity:	Up to 90 % non-condensing
Altitude:	5000 m
Storage Temperature:	-20 °C to +75 °C
Humidity:	Up to 90 % non-condensing
Altitude:	15000 m

## Product Order Codes

### 4[A]-785C-[B][C][D][E]

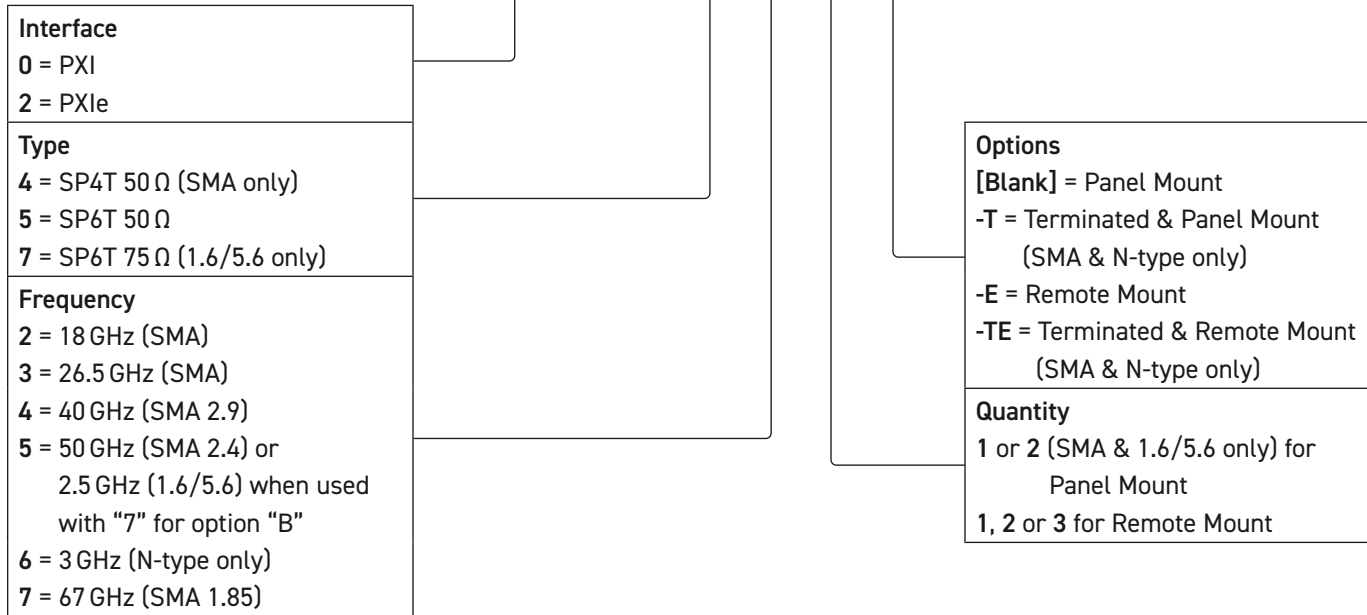

Example part numbers:

A PXI dual SP6T, 40 GHz terminated, panel mount module would require part number **40-785C-542-T**

A PXIe single SP4T, 26.5 GHz, unterminated, remote mount module would require part number **42-785C-431-E**

## Product Order Codes Suggested Alternatives

The following products are available for all users but consideration should be given to the 4x-784B product range. The 4x-784B range provides comparable performance to the 4x-785C family for unterminated relays rated to 40 GHz with the density and slot count advantages of up to three panel mounted multiplexers in just two PXI/PXIe slots.

- 18 GHz versions in the range of **4x-785C-y2z{-E}**
- 26.5 GHz versions in the range of **4x-785C-y3z{-E}**
- 40 GHz versions in the range of **4x-785C-y4z{-E}**

Please refer to the user manual for all individually defined valid part numbers.

## Connection Accessories

For a complete list of connection accessories and documentation for the 4x-785C module please refer to our [RF connectors datasheet \(90-011D\)](#).

## Warranty

This module carries a 3 year warranty. The warranty specifically applies to only the cold switching operations of the relay within the stated lifetime.

## Accessories:

### Microwave relay bracket for remote mounting:

Bracket for unterminated, SMA, SMA 2.9, SMA 2.4 or SMA 1.85	40-785A-521-E-MB
---	------------------

Bracket for terminated, SMA, SMA 2.9 or SMA 2.4	40-785A-531-TE-MB
---	-------------------

Bracket for unterminated or terminated, N-type	40-785A-561-TE-MB
--	-------------------

**Note:** A single relay is mounted to each bracket, see user manual for details. To mount more than one relay, order multiples of the required part number.

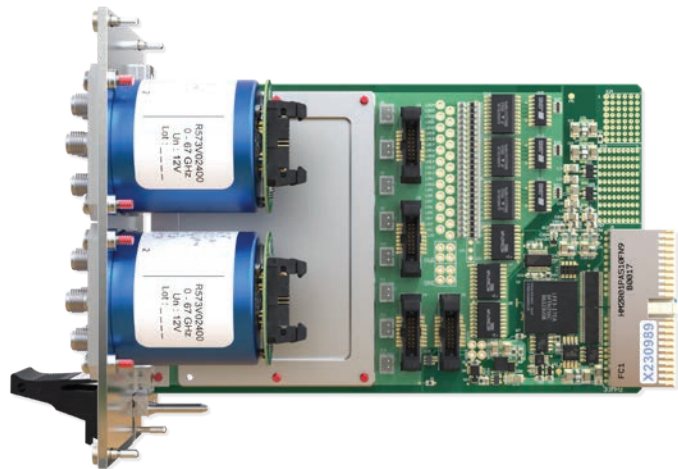

Side View of the PXI Dual Underterminated Microwave Multiplexer

## Product Customization

Pickering modules are designed and manufactured on our own flexible manufacturing lines, giving complete product control and enabling simple customization to meet very specific requirements. Customization can include:

- Alternative relay types
- Mixture of relay types
- Alternative number of relays
- Different performance specifications

All customized products are given a unique part number, fully documented and may be ordered at any time in the future. Please contact your local sales office to discuss.



42-785C-571-T PXIe Single SP6T Terminated Microwave Multiplexer

## PXI & CompactPCI Compliance - 40-785C

The module is compliant with the PXI Specification 2.2. Local Bus, Trigger Bus and Star Trigger are not implemented.

Uses a 33 MHz 32-bit backplane interface.

## PXIe Compliance - 42-785C

The module is compliant with the PXIe Specification 1.0. Local Bus, Trigger Bus & Star Trigger are not implemented.

## Safety & CE Compliance

All modules are fully CE compliant and meet applicable EU directives:

Low-voltage safety EN61010-1:2010,  
EMC Immunity EN61326-1:2013,  
Emissions EN55011:2009+A1:2010.



The 4x-785C is part of a range of switching modules suitable for RF and microwave applications.

## Pickering's Range of PXI & PXIe Microwave Switching Modules

Switch Type	Banks	Frequency Range	Model No.
SPDT Unterminated	1, 2, 3 or 4 Panel Mount, 1, 2 or 3 Remote Mount	2.5 GHz (75Ω) or 12.4 - 67 GHz (50Ω)	4x-780B
SPDT Terminated	1 or 2 Panel Mount	18 - 50 GHz (50Ω)	4x-781A
Transfer Switch	1 or 2 Panel Mount	18 - 50 GHz (50Ω)	4x-782B
SP4T or SP6T Unterminated	1, 2 or 3 Panel Mount, 1, 2 or 3 Remote Mount	6 - 40 GHz (50Ω)	4x-784B
SP4T or SP6T Terminated or Unterminated	1 or 2 Panel Mount, 1, 2 or 3 Remote Mount	2.5 GHz (75Ω) or 3 - 67 GHz (50Ω)	4x-785C
SP8T, SP10T or SP12T Terminated or Unterminated	1 or 2 Panel Mount, 1 or 2 Remote Mount	8 - 26.5 GHz (50Ω)	4x-788



## Chassis Compatibility

The PXI versions of this module are compatible with the following chassis types:

- All chassis conforming to the 3U PXI and 3U Compact PCI (cPCI) specification
- Legacy and Hybrid Peripheral slots in a 3U PXI Express (PXIe) chassis
- Pickering Interfaces LXI or LXI/USB Modular Chassis

The PXIe versions of this module are compatible with the following chassis types:

- All chassis conforming to the 3U PXIe specification
- PXIe and Hybrid Peripheral slots in a 3U PXI Express (PXIe) chassis

## Chassis Selection Guide

### PXI and PXIe (with PXIe and/or Hybrid slots) Chassis from any Vendor:

- Mix our 1000+ PXI/PXIe switching & simulation modules with any vendor's PXI/PXIe instrumentation
- Embedded or remote Windows PC control
- Real-time Operating System Support
- High data bandwidths, especially with PXI Express
- Integrated module timing and synchronization



### Pickering LXI or LXI/USB Modular Chassis Only accept our PXI Switching & Simulation Modules:

- Choose from 1000+ Pickering PXI Modules
- Ethernet or USB control enables remote operation
- Low-cost control from practically any controller
- LXI provides manual control via Web browsers
- Driverless software support
- Power sequencing immunity
- Ethernet provides chassis/controller voltage isolation
- Independence from Windows operating system





## Programming

Pickering provide kernel, IVI and VISA (NI & Keysight) drivers which are compatible with all Microsoft supported versions of Windows and popular older versions.

For more information go to [pickeringtest.com/os](http://pickeringtest.com/os)

The VISA driver support is provided for LabVIEW Real Time Operating Systems (Pharlap and Linux-RT). For other RTOS support contact Pickering. These drivers may be used with a variety of programming environments and applications including:

- Pickering Interfaces Switch Path Manager
- National Instruments products (LabVIEW, LabWindows/CVI, Switch Executive, MAX, TestStand, VeriStand, etc.)
- Microsoft Visual Studio products (Visual Basic, Visual C++)
- Programming Languages C, C++, C#, Python
- Keysight VEE and OpenTAP
- Mathworks MATLAB, Simulink
- Marvin ATEasy
- MTQ Testsolutions Tecap Test & Measurement Suite

Drivers for popular Linux distributions are available, other environments are also supported, please contact Pickering with specific enquiries. We provide Soft Front Panels (SFPs) for our products for familiarity and manual control, as well as comprehensive documentation and example programs to help you develop test routines with ease.

To learn more about software drivers and development environments go to [pickeringtest.com/software](http://pickeringtest.com/software)

## Signal Routing Software

Our signal routing software, Switch Path Manager, automatically selects and energizes switch paths through Pickering switching systems. Signal routing is performed by simply defining test system endpoints to be connected together, greatly accelerating Test System software development.

To learn more go to [pickeringtest.com/spm](http://pickeringtest.com/spm)

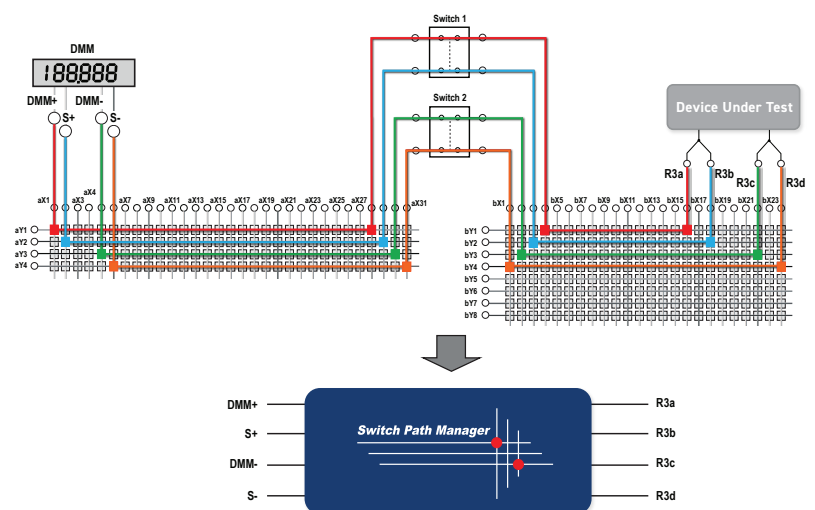



## Diagnostic Relay Test Tools

**eBIRST** Switching System Test Tools are designed specifically for our PXI, PCI or LXI products, these tools simplify switching system fault-finding by quickly testing the system and graphically identifying the faulty relay.

To learn more go to [pickeringtest.com/ebirst](http://pickeringtest.com/ebirst)



## Three Year Warranty & Guaranteed Long-Term Support

All standard products manufactured by Pickering Interfaces are warranted against defective materials and workmanship for three years from the date of delivery to the original purchaser. Extended warranty and service agreements are available with various levels for your requirements. Although we offer a 3-year warranty as standard, we also include guaranteed long-term support—with a history of supporting our products for typically 15-20 years.

To learn more go to [pickeringtest.com/support](http://pickeringtest.com/support)

## Available Product Resources

We have a library of resources including success stories, product and support videos, articles and white papers as well as application-specific brochures to assist you. We have also published reference books on switching technology and the PXI and LXI standards.

To view, download or request any of our product resources go to [pickeringtest.com/resources](http://pickeringtest.com/resources)

